



Gas Detector

Biosystems PHD6

Reference Manual



Sperian Instrumentation
651 South Main Street
Middletown, CT 06457
800 711-6776 860 344-1079
Fax 860 344 – 1068
12MAR2009
Part Number 13-322
Version 2.01
<http://www.biosystems.com>

WARNING

BIOSYSTEMS PHD6 PERSONAL PORTABLE GAS DETECTORS HAVE BEEN DESIGNED FOR THE DETECTION AND MEASUREMENT OF POTENTIALLY HAZARDOUS ATMOSPHERIC CONDITIONS

IN ORDER TO ASSURE THAT THE USER IS PROPERLY WARNED OF POTENTIALLY DANGEROUS ATMOSPHERIC CONDITIONS, IT IS ESSENTIAL THAT THE INSTRUCTIONS IN THIS REFERENCE MANUAL BE READ, FULLY UNDERSTOOD, AND FOLLOWED.

**Biosystems PHD6
Reference Manual
Part Number 13-322
Version 2.01
Copyright 2009**

**by
Sperian Protection Instrumentation, LLC
Middletown, Connecticut 06457**

All rights reserved.

No page or part of this operation manual may be reproduced in any form without written permission of the copyright owner shown above.

**Sperian reserves the right to correct typographical errors.
Specifications are subject to change without notice.**

Table of Contents

CERTIFICATION INFORMATION	4
OPERATING TEMPERATURE AND HUMIDITY LIMITS	4
SIGNAL WORDS	4
WARNINGS AND CAUTIONS	4
1. DESCRIPTION	6
1.1 Methods of sampling	6
1.2 Multi-sensor capability	6
1.3 Calibration	6
1.4 Alarm logic	6
1.4.1 Atmospheric hazard alarms	7
1.4.2 Low battery alarms	7
1.4.3 Sensor over range alarms	7
1.4.4 PID lamp out alarm	7
1.4.5 LEL response failure due to lack of O ₂ alarm	7
1.4.6 Security beep/flash	7
1.4.7 Latching alarms	7
1.4.8 Fault detection	8
1.5 Other electronic safeguards	8
1.6 Sensors	8
1.7 Optional sample draw pump	8
1.7.1 Special precautions when using the PHD6 pump	8
1.8 Data storage	8
1.8.1 Black box data recorder	9
1.8.2 Event logger	9
1.9 PHD6 design components	9
1.10 PHD6 standard accessories	9
1.10.1 Alkaline PHD6 detectors	10
1.10.2 Li-Ion PHD6 detectors	10
1.11 PHD6 kits	10
1.11.1 PHD6 Confined Space Kits	10
1.11.2 PHD6 Value Packs	10
2. BASIC OPERATIONS	10
2.1 Turning the PHD6 On	10
2.1.1 Start up with pump	11
2.1.2 Start up with PID or IR sensor	11
2.2 Operating Logic	11
2.2.1 Status Bar	11
Battery Status Icon	11
Heartbeat Symbol	12
Pump Status Icon	12
Calibration and Bump Due Warnings	12
Time	12
2.2.2 Screen Flip	12
2.3 Turning the PHD6 Off	12
2.4 Atmospheric Hazard Alarms	12
2.4.1 O ₂ Alarms	12
2.4.2 Combustible Gas Alarms	12
2.4.3 Toxic and VOC sensor alarms	12
2.4.4 Alarm Descriptions	12
Warning Alarms	12
Danger Alarms	13
STEL Alarms	13
TWA Alarms	13
2.5 Other Alarms	13
2.5.1 Missing Sensor Alarms	13
2.5.2 Sensor Overrange alarm	13
2.5.3 PID Lamp Out Alarm	13
2.5.4 O ₂ Too Low for LEL Alarms	13
2.5.5 Low Battery Alarms	13
2.5.6 Calibration Due Warning	14
2.5.7 Out of Temperature Range	14

2.6	PC Connection via Infrared Port	14
2.7	PID sensor reactivity ratios	14
2.7.1	Displayed VOC	14
2.7.2	Specified VOC Calibration Gas	15
2.8	Special Instructions for NDIR sensors	15
2.8.1	Special Calibration Requirement for NDIR CO ₂ (Carbon Dioxide) Sensor	15
2.8.3	Hydrogen Warning for IR CH ₄ Methane Sensor	15
3.	SAMPLING	15
3.1	Manual sample draw kit	15
3.1.1	Manual sample draw kit usage	15
3.2	Motorized sample draw pump	16
3.2.1	Starting the motorized sample pump	16
3.2.2	Turning off the pump	17
3.2.3	Pump low flow alarm	17
3.3	Sample draw probe	17
4.	CALIBRATION	17
4.1	Functional (Bump) testing	18
4.2	Fresh Air/Zero Calibration	18
4.2.1	Fresh air calibration failure	19
4.2.2	Forced fresh air calibration	19
4.2.3	Fresh air calibration in a contaminated atmosphere	19
4.3	Gas Calibration	19
4.3.1	Gas calibration failure: All sensors except oxygen	20
4.3.2	Gas calibration failure: Oxygen sensors	20
4.4	Special Calibration Instruction for NDIR CO₂ sensor	21
4.4.1	CO ₂ Sensor True Zero	21
4.5	Special Calibration Instructions for NDIR-CH₄ Sensor	21
5.	MENU OPTIONS	21
5.1	Basic Menu	21
5.1.1	Entering the Basic Menu	21
5.2	Main Menu	21
5.2.1	Entering the Main Menu	22
5.2.2	Using the submenus.	22
5.2.3	Alarms Menu	22
5.2.4	Calibration Menu	22
5.2.5	Configuration Menu	23
5.2.6	Screen Menu	24
5.2.7	Information Menu	24
5.2.8	Datalogger Menu	24
6.	MAINTENANCE	24
6.1	Batteries	24
6.2	Replacing alkaline batteries	24
6.3	Maintaining Li-Ion battery packs	25
6.3.1	Storage guidelines for the Li-Ion battery	25
6.3.2	Charging guidelines for Li-Ion battery	25
6.3.3	Charging procedure for Li-Ion battery	25
6.3.4	Charging with the pump attached	25
6.3.5	Battery troubleshooting	25
6.4	Sensors	25
6.4.1	Sensor replacement	25
6.4.2	Care and maintenance of PID sensors	26
6.4.2.1	Troubleshooting the PID	26
6.4.2.2	Cleaning and replacing PID components	26
6.5	Sample probe assembly	26
6.5.1	Changing sample probe filters	27
6.5.2	Changing sample probe tubes (wands)	27
6.6	PHD6 Pump Maintenance	27
6.6.1	Replacing pump filters	27
APPENDICES		28
Appendix A	Toxic gas measurement – Warning, Danger, STEL and TWA alarms	28
1.	Warning and Danger Alarms	28
2.	Time Weighted Average (TWA)	28
3.	Short Term Exposure Limits (STEL)	28
Appendix B	Calibration Frequency Recommendation	29

Appendix C PHD6 Sensor Information	30
Appendix D Electrochemical Toxic Sensor Cross-Sensitivity	30
** SENSOR MANUFACTURER RATES CROSS SENSITIVITY FOR HCN SENSOR TO H2S AS FOLLOWS FOR 20 PPM EXPOSURE: "SHORT GAS EXPOSURE IN MINUTE RANGE; AFTER FILTER SATURATION: CA. 40 PPM READING".	
SPIERIAN INSTRUMENTATION WARRANTY GAS DETECTION PRODUCTS	30
SPIERIAN INSTRUMENTATION WARRANTY GAS DETECTION PRODUCTS	31

Certification Information

The PHD6 carries the following certifications (as of 6/1/2008):

SGS USTC Class I Division 1 Groups A,B,C,D Temp Code T3C (Approved to UL 913)

SGS USTC Class II Division 1 Groups E,F,G (Approved to UL 913)

SGS USTC Class III (Approved to UL 913)

CSA Class I, Division 1 Groups A,B,C,D Temp Code T3C

ONLY THE COMBUSTIBLE GAS DETECTION PORTION OF THIS INSTRUMENT HAS BEEN ASSESSED FOR PERFORMANCE.

ATEX: Ex d ia IIC 170 °C (T3)

IECEX: Ex d ia IIC 170 °C (T3)

Operating Temperature and Humidity Limits

⚠WARNING The Biosystems PHD6's operating temperature range is printed on the label on the back of the instrument. Use of Sperian Gas Detectors outside of the instrument's specified operating temperature range may result in inaccurate and potentially dangerous readings.

Signal Words

The following signal words, as defined by ANSI Z535.4-1998, are used in the PHD6 Reference Manual.

⚠DANGER indicates an imminently hazardous situation which, if not avoided, will result in death or serious injury.

⚠WARNING indicates a potentially hazardous situation which, if not avoided, could result in death or serious injury.

⚠CAUTION indicates a potentially hazardous situation, which if not avoided, may result in moderate or minor injury.

CAUTION used without the safety alert symbol indicates a potentially hazardous situation which, if not avoided, may result in property damage.

Warnings and Cautions

- ⚠WARNING** The PHD6 personal, portable gas detector has been designed for the detection of dangerous atmospheric conditions. An alarm condition indicates the presence of a potentially life-threatening hazard and should be taken very seriously. Failure to immediately leave the area may result in serious injury or death.
- ⚠WARNING** In the event of an alarm condition it is important to follow established procedures. The safest course of action is to immediately leave the affected area, and to return only after further testing determines that the area is once again safe for entry. Failure to immediately leave the area may result in serious injury or death.
- ⚠WARNING** The PHD6 must be located in a non-hazardous location whenever alkaline batteries are removed from the alkaline battery pack. Removal of the alkaline batteries from the battery pack in a hazardous area may impair intrinsic safety.
- ⚠WARNING** Use only Duracell MN1500 or Ultra MX1500, Eveready Energizer E91-LR6, Eveready EN91 batteries in the alkaline battery pack. Substitution of batteries may impair intrinsic safety.
- ⚠WARNING** To reduce the risk of explosion, do not mix old or used batteries with new batteries and do not mix batteries from different manufacturers.
- ⚠WARNING** Do not charge the PHD6 with any charger other than the appropriate Sperian PHD6 charger. Standard versions of the PHD6 must be charged

with the UL/CSA-approved charger, which is Sperian part number 54-49-103-1. European versions of the PHD6 must be charged with the ATEX-approved charger, which is Sperian part number 54-49-103-5.

7. **⚠️WARNING** The PHD6 must be located in a non-hazardous location during the charging cycle. Charging the PHD6 in a hazardous location may impair intrinsic safety.
8. **⚠️WARNING** PHD6 rechargeable battery packs are supplied with Panasonic CGR18650D Lithium-Ion batteries. The Li-Ion batteries in the battery packs may not be replaced by the user. The rechargeable pack must be obtained from Sperian and replaced as a complete assembly to maintain intrinsic safety.
9. **⚠️WARNING** The accuracy of the PHD6 should be checked periodically with known concentration calibration gas. Failure to check accuracy can lead to inaccurate and potentially dangerous readings. (The Canadian Standards Association (CSA) requires an accuracy check using known concentration calibration gas prior to each day's use.)
10. **⚠️WARNING** Fresh air/zero calibrations may only be performed in an atmosphere that is known to contain 20.9% oxygen, 0.0% LEL and 0 PPM toxic gas.
11. **⚠️WARNING** The accuracy of the PHD6 should be checked immediately following any known exposure to contaminants by testing with known concentration test gas before further use. Failure to check accuracy can lead to inaccurate and potentially dangerous readings.
12. **⚠️WARNING** A sensor that cannot be calibrated or is found to be out of tolerance should be replaced immediately. An instrument that fails calibration may not be used until testing with known concentration test gas determines that accuracy has been restored, and the instrument is once again fit for use.
13. **⚠️WARNING** Do not reset the calibration gas concentration unless you are using a calibration gas concentration that differs from the one that is normally supplied by Sperian for use in calibrating the PHD6.
Customers are strongly urged to use only Sperian calibration materials when calibrating the PHD6. Use of non-standard calibration gas and/or calibration kit components can lead to dangerously inaccurate readings and may void the standard Sperian warranty.
14. **⚠️WARNING** Use of non-standard calibration gas and/or calibration kit components when calibrating the PHD6 can lead to inaccurate and potentially dangerous readings and may void the standard Sperian warranty.
Sperian offers calibration kits and long-lasting cylinders of test gas specifically developed for easy PHD6 calibration. Customers are strongly urged to use only Sperian calibration materials when calibrating the PHD6.
15. **⚠️WARNING** Substitution of components may impair intrinsic safety.
16. **⚠️WARNING** For safety reasons this equipment must be operated and serviced by qualified personnel only. Read and understand this reference manual before operating or servicing the PHD6.
17. **⚠️WARNING** A rapid up-scale reading followed by a declining or erratic reading may indicate a hazardous combustible gas concentration that exceeds the PHD6's zero to 100 percent LEL detection range.
18. **⚠️WARNING** The PHD6 is not designed for use in oxygen enriched atmospheres.
19. **⚠️WARNING** Do not use the PHD6 pump for prolonged periods in an atmosphere containing a concentration of solvent or fuel that may be greater than 50% LEL.
20. **⚠️WARNING** Do not unplug the NDIR-CH₄ or NDIR-CO₂ sensors in an explosive atmosphere. Unplugging IR sensors in an explosive atmosphere may impair intrinsic safety.

1. Description

The Biosystems PHD6 is a multi-sensor gas detector that can be configured to meet a wide variety of user requirements. This chapter provides an overview of many of the features of the PHD6. More detailed descriptions of the specific features of the PHD6 are contained in the subsequent chapters of this manual.

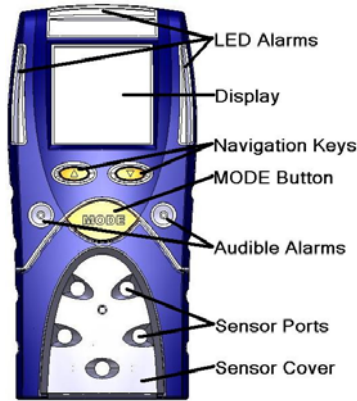

1.1 Methods of sampling

The PHD6 may be used in either diffusion or sample-draw mode. In either mode, the gas sample must reach the sensors for the instrument to register a gas reading. The sensors are located at the lower front of the instrument.

⚠WARNING The sensor ports must be kept free of obstruction. Blocked sensor ports can lead to inaccurate and potentially dangerous readings.

In diffusion mode, the atmosphere being measured reaches the sensors by diffusing through the sensor ports at the front of the instrument. Normal air movements are enough to carry the sample to the sensors. The sensors react quickly to changes in the concentrations of the gases being measured. Diffusion-style operation monitors only the atmosphere that immediately surrounds the detector.

The PHD6 can also be used to sample remote locations with its hand-aspirated sample-draw kit or with its motorized, continuous sample draw pump. During remote sampling, the gas sample is drawn into the sensor compartment through the probe assembly and a length of tubing. Remote sampling operations only monitor the atmosphere at the end of the sample draw probe.

Use of the hand-aspirated sample draw kits is covered in section 3.1.

Use of the motorized sample draw pump is covered in section 3.2.

A detailed description of the PHD6 probe assembly is given in section 6.5

1.2 Multi-sensor capability

The PHD6 can be configured to simultaneously monitor oxygen, combustible gases and vapors, volatile organic compounds (VOCs), and a wide

variety of toxic gases. All sensors are replaceable in the field.

Note: The accuracy of the PHD6 must be verified by calibration with known concentration test gas whenever a change is made to the sensors installed in the instrument.

Calibration procedures are discussed in detail in Chapter 4.

The PHD6 can utilize a variety of sensor types to detect atmospheric contaminants including electrochemical sensors, PID (Photo Ionization Detector) sensors, NDIR (Non-Dispersive Infra-Red Absorbance) sensors and catalytic hot-bead LEL sensors.

Different measurement units are used depending on the gas being measured.

Type of Hazard	Measurement unit
Oxygen (O ₂)	Percentage by volume
Combustible gas (LEL Sensor)	Percentage of lower explosive limit (%LEL) or %Vol CH ₄
Hydrocarbon-specific combustible gas sensor (NDIR – CH ₄)	Percentage of lower explosive limit (%LEL) or transitional PPM - %Vol CH ₄
Volatile Organic Compounds (VOCs) (PID Sensor)	Parts-per-million (PPM) or tenths of a part-per-million (0.1PPM)
Toxic Gases (by electrochemical sensor or by NDIR – CO ₂ sensor)	Parts-per-million (PPM) – some sensors capable of tenths of a part-per-million (0.1PPM)

Table 1.2. PHD6 Units of Measurement.

1.3 Calibration

The PHD6 detector features fully automatic fresh air and gas calibration.

⚠WARNING The accuracy of the PHD6 should be checked periodically with known concentration calibration gas. Failure to check accuracy can lead to inaccurate and potentially dangerous readings. (The Canadian Standards Association (CSA) requires an accuracy check using known concentration calibration gas prior to each day's use.)

Calibration procedures are discussed in detail in Chapter 4.

Recommended calibration frequency is discussed in Appendix B.

1.4 Alarm logic

PHD6 gas alarms can be adjusted manually using the PHD6's built in menu functions, with BioTrak software via IrDA interface, or with the IQ Database Manager Program through the PHD6

IQ Express Dock. (See Chapter 6 for direct menu programming instructions). Alarms may be set anywhere within the nominal range of the specific sensor. When an alarm set point is exceeded a loud audible alarm sounds, and the bright red LED alarm lights flash.

1.4.1 Atmospheric hazard alarms

⚠WARNING PHD6 portable gas detectors have been designed for the detection of deficiencies of oxygen, accumulations of flammable gases and vapors, and accumulations of specific toxic gases. An alarm condition indicating the presence of one or more of these potentially life-threatening hazards should be taken very seriously. Failure to immediately leave the area may result in serious injury or death.

⚠WARNING In the event of an alarm condition it is important to follow established procedures. The safest course of action is to immediately leave the affected area, and to return only after further testing determines that the area is once again safe for entry. Failure to immediately leave the area may result in serious injury or death.

⚠WARNING A rapid up-scale reading followed by a declining or erratic reading may indicate a hazardous combustible gas concentration that exceeds the PHD6's zero to 100 percent LEL detection range. Failure to immediately leave the area may result in serious injury or death.

The combustible gas alarms are activated when the reading for combustible gases exceeds one of the alarm setpoints. Combustible gas readings are typically given in terms of percent of LEL (Lower Explosive Limit), but may also be shown in terms of percent-by-volume methane (CH₄). The PHD6 includes Warning and Danger alarms for the both the LEL sensor and the NDIR-CH₄ sensor.

Two oxygen alarm set points have been provided; a low alarm for oxygen deficiency and a high alarm for oxygen enrichment.

Up to four alarm set points are provided for the PID sensor and for each toxic gas sensor: Warning, Danger, STEL (Short Term Exposure Limit) and TWA (Time Weighted Average).

Appendix A discusses Warning, Danger, STEL and TWA alarms.

1.4.2 Low battery alarms

The PHD6 includes multi-staged alarms for both the Li-Ion and alkaline battery packs to let the user know that the battery is running low.

For detailed information concerning the low battery alarms, see section 2.5.5.

⚠WARNING Use only Duracell MN1500 or Ultra MX1500, Eveready Energizer E91-LR6,

Eveready EN91 batteries. Substitution of batteries may impair intrinsic safety.

1.4.3 Sensor over range alarms

The PHD6 will go into alarm if a sensor is exposed to a concentration of gas that exceeds its established range. In the case of an LEL or NDIR-CH₄ sensor reading that exceeds 100% LEL, the sensor channel will be automatically disabled by the instrument and the instrument will remain in constant alarm until it is turned off, brought to an area that is known to be safe, and then turned back on. The display will show a vertical arrow with two heads in place of the sensor reading for any channel that has gone into over range alarm.

See section 2.5.2 for further details.

⚠WARNING In the event of an LEL overrange alarm the PHD6 must be turned off, brought to an area that is known to be safe and then turned on again to reset the alarm.

1.4.4 PID lamp out alarm

The PHD6 monitors the status of the PID lamp to ensure that it is functioning properly. Alarms are generated if the PHD6 determines that the lamp is out. See section 2.5.3 for further details

1.4.5 LEL response failure due to lack of O₂ alarm

The PHD6 features automatic warning against LEL sensor response failure due to lack of oxygen. See section 2.5.4 for details.

1.4.6 Security beep/flash

The PHD6 includes a security beep function that is designed to notify the user that the instrument is powered up and running. Once enabled the PHD6 will emit a short audible beep and give a short flash on the LED at a user-defined interval.

The security beep/flash can be enabled manually through the Main Menu (see chapter 5), with BioTrak software or through the PHD6 IQ Express Dock.

1.4.7 Latching alarms

The PHD6's alarms are self-resetting unless the alarm latch is enabled. With the PHD6's alarm latch enabled, the audible and visible alarms will continue to sound after the atmospheric hazard has cleared. To reset the alarms, simply press the MODE button. If the alarm latch is disabled and the alarm condition is no longer present, the instrument will automatically return to normal operation, and the visible and audible alarms cease without further input from the user.

Latching alarms can be enabled manually through the Main Menu (see chapter 5), with BioTrak software or through the PHD6 IQ Express Dock.

1.4.8 Fault detection

PHD6 software includes a number of additional alarms designed to ensure the proper operation of the instrument. When the PHD6 detects that an electronic fault or failure condition has occurred, the proper audible and visible alarms are activated and an explanatory message is displayed.

Faults and other electronic safeguards are discussed in detail in section 2.5.

⚠WARNING The PHD6 is designed to detect potentially life threatening atmospheric conditions. Any alarm condition should be taken seriously. The safest course of action is to immediately leave the affected area, and return only after further testing determines that the area is once again safe for entry.

1.5 Other electronic safeguards

Several automatic programs prevent tampering and misuse of the PHD6 by unauthorized persons. Each time the detector is turned on, the PHD6 automatically tests the LED alarm lights, audible alarm, internal memory and pump status (if so equipped). The battery is monitored continuously for proper voltage. The PHD6 also monitors the connection of sensors that are currently installed. The detection of any electronic faults causes the activation of the audible and visible alarms and causes the display of the appropriate explanatory message.

1.6 Sensors

The PHD6 can be configured to simultaneously monitor oxygen, combustible gases and vapors, volatile organic compounds (VOCs) and a number of toxic gases. The sensor configuration of the PHD6 may be specified at the time of purchase, or changed in the field by appropriately trained personnel.

The PHD6 must be calibrated following any sensor replacement.

Replacement sensor part numbers and sensor ranges are given in Appendix C.

⚠WARNING A sensor that cannot be calibrated or is found to be out of tolerance must be replaced immediately. An instrument that fails calibration may not be used until testing with known concentration test gas determines that accuracy has been restored, and the instrument is once again fit for use.

Calibration procedures are discussed in detail in Chapter 4.

1.6.1 Cross Sensitivity

Sensor cross-sensitivity figures are given in Appendix D.

The CO channel in the Duo-Tox sensor in the PHD6 may exhibit high levels of cross sensitivity to organic vapors (VOCs). For best performance

in an atmosphere known to contain VOCs, use a dedicated CO sensor.

1.7 Optional sample draw pump

A motorized sample-draw pump is available for the PHD6 for situations requiring continuous "hands free" remote monitoring.

⚠WARNING The PHD6 continuous sample draw pump (Sperian Instrumentation part number 54-54-102) is the only pump that can be used with the PHD6.

The pump contains a pressure sensor that detects restrictions in airflow caused by water or other obstructions being drawn into the unit and immediately acts to turn the pump off in order to protect the sensors, pump, and other PHD6 components from damage.

Pump status is continuously monitored by the PHD6 microcontroller. When the pump is active and functioning properly, the spinning pump icon is displayed in the status bar at the bottom of the display. Low flow or other pump fault conditions activate audible and visible alarms and cause the display of the appropriate explanatory message.



1.7.1 Special precautions when using the PHD6 pump

The internal material used in the PHD6's pump diaphragm seal is susceptible to temporary compromise by high levels of combustible fuels and solvents. If the PHD6 is being used in an atmosphere that may contain concentrations of combustible fuels and solvents that exceed 50% LEL, test the pump frequently to ensure that the seals have not been compromised.

To test the pump, block the sample inlet with a finger. The pump should go into alarm. If the pump fails to go into alarm while the inlet is blocked, the pump is not working properly and the PHD6 may not be providing an accurate reading. If the pump test fails, the safest course of action is to immediately leave the affected area, and return only after further testing determines that the area is once again safe for entry.

⚠WARNING Do not use the pump for prolonged periods in an atmosphere containing a concentration of solvent or fuel that may be greater than 50% LEL.

1.8 Data storage

The PHD6 includes a black box data recorder and an event logger as standard features. A full datalogger is available as an upgrade at any time.

1.8.1 Black box data recorder

A black box data recorder is a standard feature in the PHD6. The “black box” is continually in operation whether the user is aware of it or not. The black box stores important information such as gas readings, turn-on times, turn-off times, temperatures, battery conditions, the most recent calibration date and settings, types of sensors currently installed, sensor serial numbers, warranty expiration and service due dates, and current alarm settings.

There is a finite amount of memory storage available in the black box data recorder. Once the memory is “full”, the PHD6 will begin to write the new data over the oldest data. The black box data recorder will store a minimum of 63 hours of data in one-minute increments before it begins to write new data over the oldest data. In this way, the newest data is always conserved.

To extract the information from the black box data recorder, the PHD6 must be returned to Sperian. Once the data is downloaded from the instrument, a report will be generated. The unit and the report will then be returned to the user. Simply call Sperian’s Instrument Service Department to obtain a return authorization number. There is no charge for the downloading service, but the user is responsible for any freight charges incurred.

The “black box” data recorder in the PHD6 can be upgraded to a fully enabled datalogger at any time. All that is required is the activation code that corresponds to the serial number of the PHD6 and the PHD6 Upgrade Utility Program.

1.8.2 Event logger

The event logger in the PHD6 stores data associated with alarm conditions. Each (alarm) event includes the following data for each of the installed sensors:

- Sensor type
- Max reading
- Average reading
- Start time
- End time
- Duration of the event.

The PHD6 stores the data from the 20 most recent alarm events. Once 20 events have been stored, the PHD6 will begin to systematically overwrite the data from the oldest event in memory with data from new events. One event may be a combination of different alarms occurring simultaneously or in immediate succession. The event logger may be downloaded using BioTrak software. The PC must be equipped with IrDA to provide a connection.

1.9 PHD6 design components

1. **Case:** The instrument is enclosed in a solid PC (polycarbonate) case with TPE (rubber) overmold.
2. **Front face:** The front face of the instrument houses the MODE button, navigation keys, LCD (liquid crystal display), LED alarm lights, and audible alarm ports.
3. **Display:** A liquid crystal display (LCD) shows readings, messages, and other information.
4. **Alarm LEDs:** Top, front and side-mounted LED (light emitting diode) alarm lights provide a visual indication of alarm state.
5. **Infrared Port:** The infrared port is located at the bottom of the instrument and is used for communication between the PHD6 and a PC.
6. **On / Off "MODE" button:** The large black push-button on the front of the instrument is the "MODE" button. The MODE button is used to turn the PHD6 on and off as well as to control most other operations, including the initiation of the automatic calibration adjustment.
7. **Navigation Keys:** The up and down navigation keys are located between the MODE button and the display.
8. **Sensor compartment cover:** The sensors are located in a vented compartment at the bottom of the instrument.
9. **Audible alarm ports:** Two cylindrical ports extending through the front of the instrument on opposing sides of the MODE button house the loud audible alarms. The waterproof audible alarms seat directly to the rubber inner-liner to protect the instrument against leakage or exposure to liquids.
10. **Battery pack:** Two types of interchangeable battery packs (rechargeable Lithium Ion (Li-Ion) and disposable alkaline) are available for use. Li-Ion battery packs are recharged with the pack installed on the PHD6.
11. **Battery charger connector:** A water-resistant connector at the bottom of the case assembly is used to connect the PHD6 to the “drop in” style charger.
12. **Battery Compartment / Clip:** The battery inserts from the back of the instrument. A sturdy clip attached to the battery allows the user to wear the PHD6 on a belt or other article of clothing.

1.10 PHD6 standard accessories

Standard accessories included with every PHD6 include calibration adapter, additional tubing for use during calibration, manual sample draw kit, reference manual and quick reference card. The manual sample draw kit consists of a sample draw / calibration adapter, squeeze bulb, replacement sample probe filters, ten feet of tubing and a sample probe.

Standard configurations of the PHD6 are delivered in a cardboard box with cardboard inserts.

1.10.1 Alkaline PHD6 detectors

If the PHD6 has been purchased as an alkaline instrument, the standard accessories include an alkaline battery pack and a set of 3 disposable AA alkaline batteries.

1.10.2 Li-Ion PHD6 detectors

If the PHD6 has been purchased as a Li-Ion rechargeable instrument, the standard accessories include Li-Ion battery pack and a slip-in PHD6 charger.

1.11 PHD6 kits

PHD6 detectors may also be purchased as part of a complete kit that includes calibration gas, fixed-flow regulator and a hard-shell carrying case.

1.11.1 PHD6 Confined Space Kits

In addition to the standard accessories listed above, Confined Space Kits also include calibration fittings, fixed-flow regulator with pressure gauge, and appropriate large cylinder(s) of calibration gas in a foam-lined, waterproof hard-shell carrying case.

1.11.2 PHD6 Value Packs

PHD6 Value Packs include an alkaline PHD6, all standard accessories, calibration fittings, small cylinder of calibration gas, and fixed flow regulator in a foam-lined non-waterproof hard-shell carrying case.

2. Basic Operations

The PHD6 is a three-button gas detector. Most day-to-day functions are initiated solely with the MODE button. The MODE button controls:

- Turning the PHD6 on and off
- Turning on the backlight
- Viewing the MAX, STEL and TWA reading screens
- Initiating the calibration sequence

2.1 Turning the PHD6 On

To turn the PHD6 on, press and hold the MODE button for one second. The introduction screen is followed by a screen showing a list of installed sensors and the sensor ports they occupy. The PHD6 has 5 sensor ports, but can display readings for as many as 6 distinct gases.

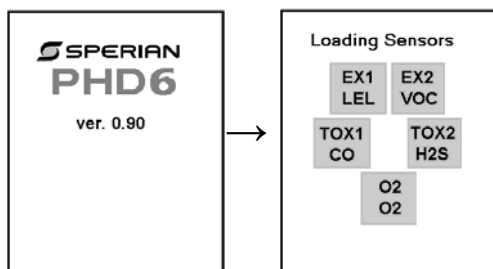

The serial number will then be shown. If the detector has a fully enabled datalogger, the interval and memory capacity will be shown.

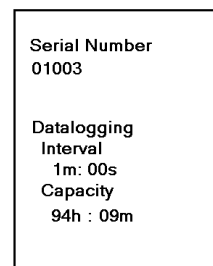

The sampling interval is given in minutes and seconds. The datalogger samples continuously, so the data stream must be broken into intervals to be recorded. The datalogging interval defines the frequency of the breaks in the data stream. The capacity is the number of hours and minutes it will take to completely fill the datalogger's memory. Once the memory is filled, the PHD6 will start to write new data over the oldest data in order to conserve that most recent data.

The sampling interval in the fully enabled datalogger may be modified using BioTrak Software, the IQ Systems or manually through the Main Menu.

If the PHD6 is equipped with the standard black box datalogger, it will show Black Box.

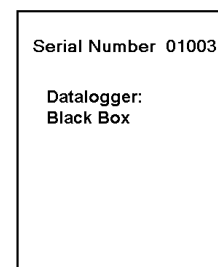

In the PHD6, a one-minute sampling interval will result in the ability to store a minimum of 63 hours of readings before the oldest data is overwritten by new data. If fewer than 5 sensors are used, the capacity will increase.

As the instrument performs a basic electronic self test, the date, time, temperature and battery type will be displayed. During the self-test, the PHD6 performs a system memory check and tests to see if a motorized pump is attached to the instrument. If a pump is detected, it will be briefly activated during the self-test. For details on start up procedures for pump-equipped PHD6 instruments see section 2.1.1 below.

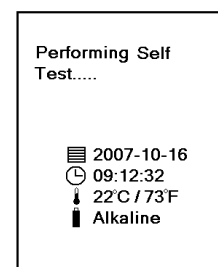

The PHD6 will then display each installed sensor along with any associated alarms levels.

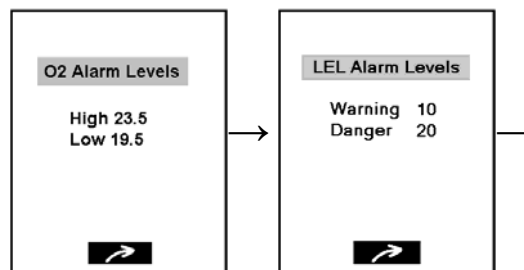

VOC Alarm Levels		CO Alarm Levels	
Warning	50	Warning	35
Danger	100	Danger	100
STEL	25	STEL	100
TWA	10	TWA	35

For more information concerning atmospheric hazard alarms, see section 2.4.

After the alarm screens, the PHD6 will show that "Starting Session, Resetting Averages" followed by the calibrations status screen. Whenever the PHD6 is turned on, it automatically starts a new operating session and resets STEL and TWA calculations. The MAX reading is also reset for the new session.

Starting Session, Resetting Averages	▲ Gas Cal Due LEL VOC SO2 CO H2S
--------------------------------------	---

If calibration is due and the calibration due warning is enabled, the user will need to acknowledge the calibration due status by pressing the MODE button. Once the MODE button is pressed, the PHD6 will continue to the current gas readings screen and the appropriate calibration due icons will flash to remind the user that the instrument is past due for calibration. If calibration is not due, the number of days until the next calibration will be shown before the instrument proceeds to the current gas readings screen.

2.1.1 Start up with pump

PHD6 instruments that are equipped with a built-in motorized sample draw pump will have a slightly longer start up sequence. After the calibration status screens, the PHD6 will prompt you to leak test the pump.

See section 3.2 for further instructions on using the PHD6 pump.

2.1.2 Start up with PID or IR sensor

When a PID or IR sensor is installed in the PHD6, there will be a warm-up period during which the hourglass icon and either "PID" or "IR" will be shown. The VOC gas type and reading are shown in reverse text.



⚠ WARNING PID and IR readings that are displayed during the sensor warm up period should not be considered accurate. The use of the PHD6 to monitor for compounds detected by the PID or IR sensor during the warm up period may lead to inaccurate and potentially dangerous readings.

2.2 Operating Logic

Once the PHD6 has completed the start up sequence, the current gas readings screen will be shown. The status bar at the bottom of the display shows time plus calibration, pump and battery status.

To turn on the backlight press the MODE button once. To view the peak readings screen, press the MODE button a second time. Press the MODE button a third time to view the Short Term Exposure Limit (STEL) and Time Weighted Averages (TWA) for the operating session.

O2 Min	Peak	STEL	TWA
O2 Max	20.6	VOC	0 0
LEL	21.0	SO2	0 0
VOC	0	CO	0 0
SO2	0	H2S	0 0
CO	7		
H2S	0		

⌚ 3:42 ⬇ 73°F

Screens that are accessible with the MODE button (including the Peak and STEL/TWA screens) are selectable by the user. See section 5.2.6 for details.

Note: The PHD6 must be in continuous operation for at least 15 minutes before it will be able to calculate STEL or TWA values. For the first 15 minutes of any operating session, the screen will show the length of time that the instrument has been operating instead of the STEL and TWA values.

2.2.1 Status Bar

The status bar at the bottom of the current gas readings shows general information including:

- Battery Status
- Heartbeat (instrument status)
- Pump Status
- PID Hourglass (PID warmup period)
- PID Lamp Status (shows "Check Sen.")
- Bump Due Warning
- Calibration Due Warning
- Time

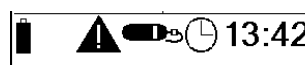

Battery Status Icon

The battery status icon is located at the far lower left of the screen. The battery icon gives an indication of how much power is left in the battery.

When the battery icon is empty, it is considered a low battery condition and the user should take the appropriate steps to either recharge the Li-Ion battery or replace the alkaline batteries.



For more information on the low battery alarms, see section 2.5.5.

IR Hourglass Symbol

The hourglass symbol along with IR are shown in the status bar during the IR sensor's 1-minute warm-up period. Once the warm-up period is over, the hourglass will no longer be shown.



PID Hourglass Symbol

The hourglass symbol along with PID are shown in the status bar during the PID sensor's 5-minute warm-up period. Once the warm-up period is over, the hourglass will no longer be shown.



When a PHD6 is equipped with both an IR and a PID sensor, the PID hourglass is shown since the PID sensor takes longer to warm up than the IR sensor.

Heartbeat Symbol

When the instrument is properly charged, calibrated and functioning normally, the heartbeat symbol will flash in the status bar.



Pump Status Icon

If the pump is attached and functioning, the moving fan icon will appear in the status bar.



Calibration and Bump Due Warnings

If the PHD6 is due for calibration the calibration bottle icon and triangular warning symbol will be flash in the status bar.



Time

The time is shown on the current gas readings screen at the lower right.

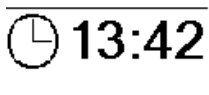

2.2.2 Screen Flip

The screen orientation of the PHD6 may be flipped (so that it can be read looking down from above instead of up from below) by pressing the up and down arrows simultaneously at the Current Gas Readings screen.

2.3 Turning the PHD6 Off

To turn the PHD6 off, press and hold the MODE button until the display reads "Release MODE to shut down". Then release the MODE button. The display

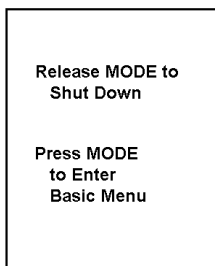

will briefly show "Shutting Down" and "Saving Sensors" before the display goes blank.

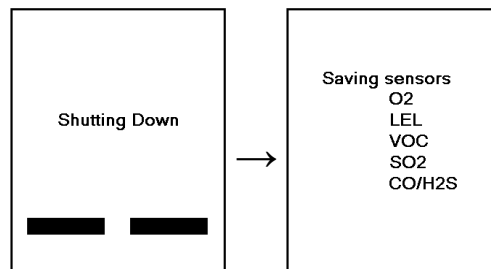

2.4 Atmospheric Hazard Alarms

The PHD6 is configured with a series of alarms that are designed to warn the user of hazardous atmospheric conditions.

⚠️WARNING The PHD6 is designed to detect potentially life threatening atmospheric conditions. Any alarm condition should be taken seriously. The safest course of action is to immediately leave the affected area, and return only after further testing determines that the area is once again safe for entry.

2.4.1 O2 Alarms

The PHD6 is equipped with both high and low alarms for oxygen. Fresh air contains 20.9% oxygen.

The low oxygen alarm indicates oxygen deficiency and is normally set at 19.5% at the factory.

The high alarm indicates oxygen enrichment and is normally set at 23.5% at the factory.

2.4.2 Combustible Gas Alarms

The PHD6 is equipped with a 2-stage alarm for concentrations of combustible gas.

The default LEL warning alarm setting is 10% LEL. The default LEL danger alarm setting is 20% LEL.

The default warning alarm for NDIR-CH₄ sensors is 10% LEL or 0.5%/vol CH₄. The default danger alarm is 20% LEL or 1.0%/vol CH₄.

2.4.3 Toxic and VOC sensor alarms

The PHD6 is equipped with up to four different alarms for toxic gases and volatile organic compounds (VOCs). The combination of alarms is designed to protect the user from both chronic and acute toxic hazards.

Current alarm settings are shown during the startup sequence, and can also be accessed through the Alarms Menu.

2.4.4 Alarm Descriptions

Warning Alarms

Warning alarms indicate a hazardous atmospheric condition that has not yet risen to the level necessary to initiate the danger alarms.

Warning alarms can be temporarily silenced by pressing the MODE button if this option is enabled with BioTrak.

Danger Alarms

Danger alarms indicate a significantly hazardous condition. The danger alarms cannot be silenced by the user.

STEL Alarms

STEL (Short Term Exposure Limit) alarm values represent the average concentration of instrument readings for the target gas for the most recently completed 15 minutes of operation.

TWA Alarms

TWA (Time Weighted Average) values are calculated by taking the sum of exposure to a particular toxic gas in the current operating session in terms of parts-per-million-hours and dividing by an eight-hour period.

2.5 Other Alarms

The PHD6 will display warnings or error messages when it detects problems during operation.

2.5.1 Missing Sensor Alarms

During startup, if the PHD6 fails to detect a sensor that was present when the instrument was last turned off, it will show the sensor channel with "None" and the triangular warning symbol at the Loading Sensors screen.

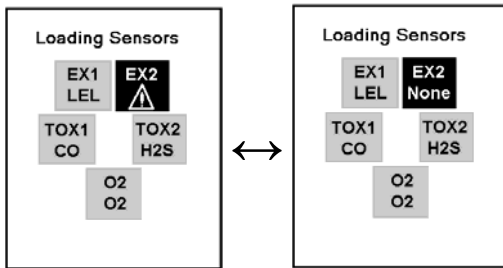

Press MODE to acknowledge the missing sensor

If the PHD6 loses connection with a sensor during an operating session, it will immediately go into alarm and show an "X" in the space on the display allotted for the sensor reading. The PHD6 must be turned off to reset the missing sensor alarm.



2.5.2 Sensor Overrange alarm

The PHD6 will show a vertical double-headed arrow and go into alarm if a sensor is exposed to a concentration of gas that exceeds its established range.

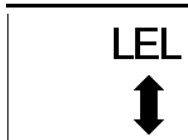

In the case of an LEL reading that exceeds 100% LEL, the LEL channel will be automatically disabled by the instrument and the alarm will latch (remain on) until the instrument is turned off. The PHD6 must be turned off, brought to an area that is known to be safe (containing 20.9% oxygen, 0% LEL and 0 PPM toxic gases), and then turned back on. The display will show a

vertical arrow with two heads in place of the sensor reading for any channel that has gone into over range alarm.

⚠WARNING A combustible sensor overrange alarm indicates a potentially explosive atmosphere. Failure to leave the area immediately may result in serious injury or death!

⚠WARNING In the event of an LEL overrange alarm the PHD6 must be turned off, brought to an area that is known to be safe (containing 20.9% oxygen, 0% combustible gases and 0 PPM toxic gases), and then turned on again to reset the alarm.

2.5.3 PID Lamp Out Alarm

The PID sensor in the PHD6 uses a lamp to ionize the gas sample and generate a reading.



If the lamp fails to light during instrument startup, the PHD6 will attempt to start it for the duration of the warm-up cycle. If the lamp lights, the PHD6 will complete the warm-up cycle and then enter standard operating mode. If the lamp fails to light by the end of the 5-minute warm-up cycle, the PID channel will be turned off and the instrument will resume normal operation with the remaining sensors.

The PHD6 also tests the lamp in the PID sensor at regular intervals during normal operation. If the PHD6 determines that the lamp has gone out, the instrument will display an X in the PID channel on the display and the instrument will go into alarm. The status bar at the bottom of the screen will also show "Check Sen." to let the user know that the PID sensor is not functioning.

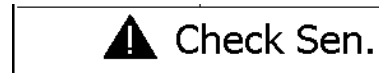

2.5.4 O₂ Too Low for LEL Alarms

The LEL sensor in the PHD6 requires a certain amount of oxygen to function properly. When oxygen levels fall below 11% by volume, the PHD6 will show "X" in place of the LEL reading and will indicate the oxygen levels are too low.

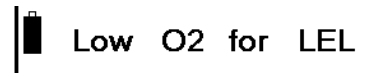

2.5.5 Low Battery Alarms

When the battery icon in the LCD appears empty, it means that a low battery condition exists. Leave the area immediately.



If the PHD6 is equipped with an alkaline battery pack, proceed to an area that is known to be safe area (containing 20.9% oxygen, 0% combustible gases and 0 PPM toxic gases) and change the batteries.

⚠WARNING The PHD6 must be located in a non-hazardous location whenever alkaline batteries are removed from the

alkaline battery pack. Removal of the alkaline batteries from the battery pack in a hazardous area may impair intrinsic safety.

CAUTION Always turn the PHD6 off prior to removing the battery pack. Removal of the battery pack with the instrument turned on may cause corruption of stored data in the PHD6.

If the PHD6 is equipped with a Li-Ion battery pack, proceed to an area that is known to be safe and recharge the battery pack.

If the PHD6 continues to be used during a low battery condition, it will eventually go into a low battery alarm, and the warning alarm will sound and the screen will display the low battery warning. To silence the alarms, the user will need to acknowledge the low battery condition by pressing the MODE button before the instrument will resume monitoring. Once the MODE button is pressed, the empty battery cell and the caution icon will flash. After 5 minutes the warning will sound again. This cycle will continue until the battery reaches a “very low battery” condition, when the instrument will go into alarm for the last time, notify the user that it is shutting itself and proceed to turn itself off.

Alkaline battery replacement and Li-Ion battery charging instructions are contained in sections 6.2 and 6.3.

⚠WARNING The PHD6 must be located in a non-hazardous location during the charging cycle. Charging the PHD6 in a hazardous location may impair intrinsic safety.

2.5.6 Calibration Due Warning

If the PHD6 is due for calibration, the triangular warning symbol and span bottle icons will flash in the status bar at the bottom of the LCD once per second as a reminder.



2.5.7 Out of Temperature Range

If the operating temperature falls outside of the normal operating range of a sensor in the PHD6, the instrument will go into alarm and the thermometer icon will be shown on the display at the sensor.

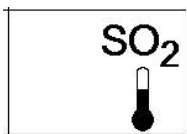

2.6 PC Connection via Infrared Port

PHD6 instruments that are equipped with a fully enabled datalogger can be downloaded to a PC using BioTrak or IQ software through the PHD6's infrared port. The IrDA port is located on the bottom of the instrument towards the back.



1. If the PHD6 is turned off, hold the MODE button down for about 5 seconds until “Communication Mode” is shown. If the PHD6 is on already, proceed to step 2.
2. Align the infrared port on the PHD6 with the PC's infrared port to complete the connection.

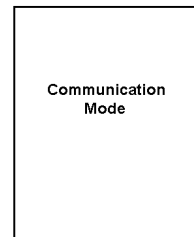

Note: For further instructions concerning the download procedure for the PHD6, see the BioTrak or IQ System manual as appropriate.

2.7 PID sensor reactivity ratios

The PHD6 may be equipped with a PID (Photo Ionization Detector) sensor designed to detect Volatile Organic Compounds. The PID sensor employs an ultraviolet lamp to ionize the VOCs in the sample. The detector is then able to measure the level of the VOCs and generate a reading.

While using the PID sensor, it's important to understand that the target gas does not need to be the same as the calibration gas. The PHD6 includes built-in VOC reactivity ratios and can generate an accurate reading for one VOC while calibrating with another VOC.

The convention in the gas detection industry is to calibrate the PID sensor to a known concentration of isobutylene and (as required) to use response factors or to select the scale of target gas from a pre-programmed menu. Sensitivity scale is displayed on the channel with 7 character designation whether it is isobutylene or another material.

2.7.1 Displayed VOC

To change the displayed VOC, first enter the Basic Menu by holding the MODE button to turn the PHD6 off. When “Release MODE to Shut Down” is shown, continue to hold the MODE Button until the Basic Menu is shown.

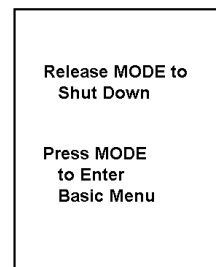

At the Basic Menu press the down arrow once to select “Displayed VOC”. A list of Volatile Organic Compounds will be shown. Use the navigation arrows to highlight the appropriate VOC and press MODE to select it. The new VOC will be shown when the PHD6 is restarted.

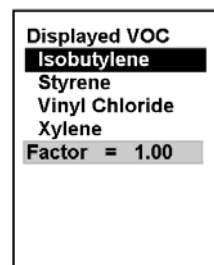
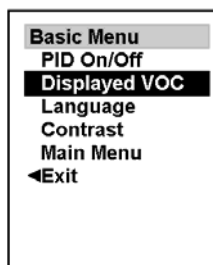

2.7.2 Specified VOC Calibration Gas

To change the calibration gas for PID sensor, follow the instruction in section 5.2.1 to reach the Main Menu. Then access the Calibration Menu followed by the Gas Values submenu. Once in the Gas Values submenu, select the VOC sensor. Then select Cal Gas Type and specify the appropriate compound and amount for calibration.

2.8 Special Instructions for NDIR sensors

Two NDIR sensors are available for the PHD6: One for the detection of carbon dioxide (CO₂), and one for the detection of methane (CH₄).

2.8.1 Special Calibration Requirement for NDIR CO₂ (Carbon Dioxide) Sensor

Unlike most sensors the Infrared CO₂ sensor requires two different gas sources to fully calibrate the instrument. The reason for this is that it is effectively impossible to zero calibrate a CO₂ detector in ambient air because there is an unknown and varying amount of background CO₂ present in the atmosphere.

See section 4.4 for more details.

2.8.2 Special Consideration for IR CH₄ Methane sensor gas calibration

The NDIR-CH₄ sensor is designed specifically for the detection of methane. Gas calibration should always be done with methane calibration gas at the actual amount of methane shown on the cylinder. See section 4.5 for details.

2.8.3 Hydrogen Warning for IR CH₄ Methane Sensor

Unlike other types of sensors used to measure combustible gases and vapors, the IR CH₄ sensor used in the PHD6 does not respond to hydrogen.

⚠WARNING Do not use the NDIR CH₄ sensor for the detection of hydrogen. Unlike catalytic hot-bead LEL sensors, the NDIR CH₄ sensor in the PHD6 does not respond to hydrogen. Use the of the NDIR CH₄ for the detection hydrogen may lead to property damage, personal injury or death.

3. Sampling

The PHD6 may be used in either diffusion or sample-draw mode. In either mode, the gas sample must reach the sensors for the instrument to register a gas reading. The sensors are located on the front of the instrument near the bottom in a vented compartment.

⚠WARNING The sensor ports must be kept free of obstruction. Blocked sensor ports can lead to inaccurate and potentially dangerous



readings.

In diffusion mode, the atmosphere being measured reaches the sensors by diffusing through vents in the instrument. Normal air movements are enough to carry the sample to the sensors. The sensors react quickly to changes in the concentrations of the gases being measured. Diffusion-style operation monitors only the atmosphere that immediately surrounds the detector.

The PHD6 can also be used to sample remote locations with either the hand-aspirated sample-draw kit, or with the motorized sample draw pump. During remote sampling, the gas sample is drawn into the sensor compartment through the probe assembly and a length of tubing.

⚠WARNING Do not use the NDIR CH₄ sensor for the detection of hydrogen. Unlike catalytic hot-bead LEL sensors, the NDIR CH₄ sensor in the PHD6 does not respond to hydrogen. Use the of the NDIR CH₄ for the detection hydrogen may lead to property damage, personal injury or even death.

3.1 Manual sample draw kit

The manual sample draw kit is comprised of a sample draw probe, 2 sections of tubing, a squeeze bulb and an adapter that is used to connect the sample draw accessories system to the PHD6.

Note: The maximum amount of tubing that can be used with the manual sample draw kit is 50 feet.

3.1.1 Manual sample draw kit usage

⚠WARNING The PHD6's manual sample draw kit may not be used for the detection of chlorine (Cl₂) or chlorine dioxide (ClO₂) due to the reactive properties of these gases.

To use the manual sample draw kit:

1. Connect the short section of hose that comes off the squeeze bulb to the sample draw adapter.
2. To test the seals in the sample draw system, cover the end of the sample draw probe with a finger, and squeeze the aspirator bulb. If there are no leaks in the sample draw kit components, the bulb should stay deflated for a few seconds.
3. Secure the calibration adapter (with the sample draw assembly attached) to the PHD6 by inserting the tab and tightening the knurled screw into the brass nut at the bottom of the adapter.

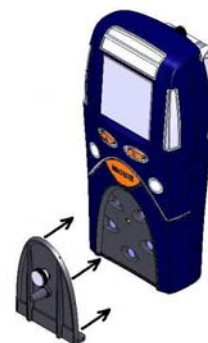

4. Insert the end of the sample probe into the location to be sampled.
5. Squeeze the aspirator bulb to draw the sample from the remote location to the sensor compartment.

To ensure accurate readings while using the manual sample draw kit, it is necessary to squeeze the bulb once for every one foot of sampling hose for the sample to first reach the sensors, and then to continue squeezing the bulb once per second for an additional 45 seconds or until readings stabilize. As an example, if 10 feet of tubing is used, it will be necessary to draw the sample in by squeezing the bulb continuously for a minimum of 55 seconds or until readings stabilize.

6. Note the gas measurement readings.

CAUTION: Hand-aspirated remote sampling only provides continuous gas readings for the area in which the probe is located while the bulb is being continuously squeezed. Each time a reading is desired, it is necessary to squeeze the bulb a sufficient number of times to bring a fresh sample to the sensor compartment.

3.2 Motorized sample draw pump

⚠WARNING The PHD6 continuous sample draw pump (Sperian Instrumentation part number 54-54-102) is the only pump that can be used with the PHD6.

A motorized sample-draw pump is available for the PHD6 for situations requiring continuous "hands free" remote monitoring. The pump is powered by the PHD6 battery. When the pump is attached to the instrument, the



spinning fan icon will be shown on the display in the current gas readings screen.

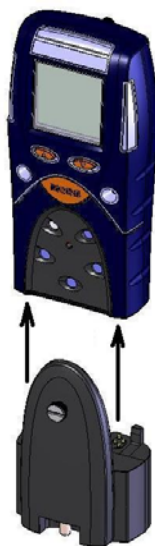

Note: The maximum amount of tubing that can be used with the motorized sample draw pump is 100 feet.

To ensure accurate readings while using the continuous sample pump, it is necessary to allow the pump to draw the sample for one second for every one foot of sampling hose plus an additional 45 seconds or until readings stabilize. For example, with 10' of tubing, it will be necessary to allow a minimum of 55 seconds for the sample to be drawn into the sensor chamber and for the readings to stabilize.

PHD6 instruments are designed to automatically recognize the pump whenever it is attached to the instrument. If the pump is attached when the PHD6 is turned off, the instrument will automatically initiate the pump start up sequence when the instrument is turned on. If the pump is attached while the instrument is running, the PHD6 will automatically initiate the pump test sequence before returning to the current gas readings screen.

⚠WARNING Do not use the PHD6 pump for prolonged periods in an atmosphere containing a concentration of solvent or fuel that may be greater than 50% LEL.

3.2.1 Starting the motorized sample pump

First attach the probe and tubing to the pump, then secure the pump (with the sample draw assembly attached) to the PHD6 by hooking the tabs on the pump into the corresponding slots on the back of the PHD6. Once the pump is in position over the sensors, tighten the knurled screw on the adapter into receptor at the center of the sensor cover.

Note: The sample probe assembly must be attached to the pump when the pump is attached to the instrument.

Once the pump is recognized, the pump test sequence will be initiated automatically. The instrument will instruct you to block the sample inlet.

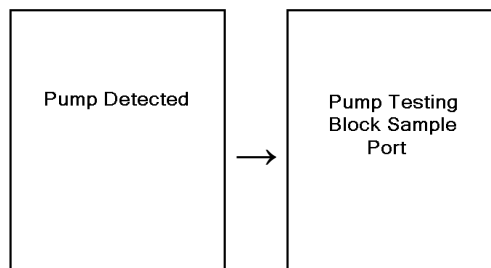

Block the sampling inlet by placing a finger over the end of the sample probe assembly. Once the blockage is detected, the PHD6 will indicate that the test has been passed and instruct you to remove the blockage. Once the blockage is removed, it will proceed to the current gas readings screen and the pump icon will be shown in the status bar.

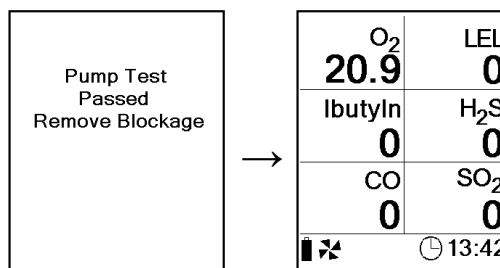

If the instrument is unable to detect the vacuum resulting from the pump blockage within 30 seconds, the test will fail, the instrument will go into alarm and you will be directed to remove the pump.

Remove the pump and press the MODE button to resume diffusion operation.

3.2.2 Turning off the pump

To turn off the pump, simply remove the pump from the bottom of the instrument. The screen will show “Pump Fault” followed by “Pump Disconnected”. Press MODE to continue without the pump.

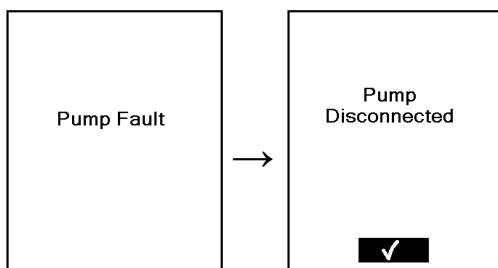

3.2.3 Pump low flow alarm

The PHD6 Pump contains a pressure sensor that continuously monitors for restrictions in airflow caused by water or other fluids being drawn into the unit and immediately acts to turn the pump off in order to protect the sensors, pump, and other PHD6 components from damage.

CAUTION: Never perform remote sampling with the PHD6 without the sample probe assembly. The sample probe handle contains replaceable filters designed to block moisture and remove particulate contaminants. If the pump is operated without the probe assembly in place, contaminants may cause damage to the pump, sensors and internal components of the PHD6

When the pump is active and functioning properly, the moving pump icon is shown on the lower status bar on the display. Low flow or other pump fault conditions activate audible and visible alarms and cause the display of the appropriate explanatory message.

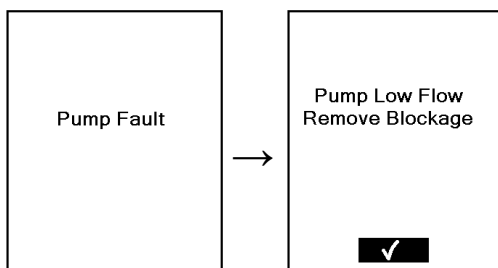

Press MODE once the blockage has been cleared to restart the pump.

The pressure sensor in the sample draw pump is designed to detect pressure changes while the sample-draw probe is being held in a vertical position. If the probe is held horizontally or at a low angle while inserted into a fluid, a pressure drop sufficient to cause the pump to shut down may not be generated, and water could be drawn into the pump assembly causing damage to the

pump, sensors and internal components of the PHD6.

CAUTION: Insertion of the sample draw tube into a fluid horizontally or at a low angle may lead to water ingress and may cause damage to the sensors and internal components of the PHD6.

If the PHD6 determines that a significant increase in pressure has occurred, it will go into alarm and notify the user that there is a blockage of the pump. The display will alternate between the following two screens.

Remove the blockage and press the MODE button to acknowledge the alarm and resume sampling.

3.3 Sample draw probe

The PHD6's sample draw probe is the standard probe assembly from Sperian. The sample probe handle contains moisture barrier and particulate filters designed to remove contaminants that might otherwise harm the instrument.

Particulate contaminants are removed by means of a cellulose filter. The hydrophobic filter includes a Teflon™ barrier which blocks the flow of moisture as well as any remaining particulate contaminants.

Sample probe filters should be replaced whenever visibly discolored due to contamination.

See section 6.5 for a probe diagram and a list of available sample probe filter replacement kits.

4. Calibration

The accuracy of the PHD6 should be verified on a regular basis. Verification can be as simple as performing a bump test, which is described below in section 4.1. If the instrument fails the fresh air test, then it must be fresh air calibrated before use. If the instrument fails the bump test with calibration gas, it must be successfully span calibrated before use.

Note: The NDIR-CO₂ sensor used in the PHD6 cannot be zero calibrated in fresh air. For specific instructions on calibrating the CO₂ sensor, proceed to section 4.4.

Note: The NDIR-CH₄ sensor used in the PHD6 must be calibrated with methane calibration scale to the actual amount of methane in the cylinder in terms of percent volume methane. See section 4.5 for details.

* **⚠ WARNING** The Canadian Standards Association (CSA) requires combustible gas sensors to be bump tested prior to each day's use with calibration gas containing between 25% and 50% LEL. The functional (bump) test procedure is covered in section 4.1.

** **⚠ WARNING** The Canadian Standards Association (CSA) requires combustible gas sensors to undergo calibration when the

displayed value during a bump test fails to fall between 100% and 120% of the expected value for the gas.

For Sperian's official recommendations concerning calibration frequency, see Appendix B.

4.1 Functional (Bump) testing

The accuracy of the PHD6 may be verified at any time by a simple functional (bump) test.

To perform a functional (bump) test, do the following:

1. Turn the PHD6 on and wait at least three minutes to allow the readings to fully stabilize. If an IR or PID sensor is in use, wait until the stabilization period ends before proceeding. If any of the sensors have just been replaced, the new sensor(s) must be allowed to stabilize prior to use. See section 6.4 for further details on sensor stabilization requirements.
2. Make sure the instrument is located in fresh air.



Figure 4.1 Bump Test / Gas calibration set up

3. Verify that the current gas readings match the concentrations present in fresh air. The oxygen (O₂) sensor should read 20.9%/vol. (+/-0.2%/vol.). The readings for the LEL sensor should be 0% LEL. The PID, NDIR-CH₄ and toxic sensors should read 0 parts-per-million (PPM) in fresh air. For the NDIR-CO₂ sensor, a carbon dioxide level between 100 PPM and 1000 PPM is considered normal in fresh air. If the readings deviate from the expected levels in a fresh air environment, proceed to section 4.2 and perform the fresh air calibration adjustment then proceed to step 4.
4. Attach the calibration adapter and connect the calibration cylinder to the PHD6 as shown in figure 4.1. Flow gas to the sensors.
5. Wait for the readings to stabilize. (Forty-five seconds to one minute is usually sufficient.)
6. Note the readings. Toxic, VOC and combustible gas sensor readings are considered accurate in a bump test if they are between 90%* and 120% of the expected reading as given on the calibration cylinder. If the readings are considered accurate, then

the instrument may be used without further adjustment. If the readings do not fall within 90%* and 120% of the expected reading as given on the calibration cylinder, then readings are considered inaccurate. If readings are considered inaccurate, proceed to section 4.3 and perform the gas calibration.

***Note: The Canadian Standards Association (CSA) requires combustible gas sensors to undergo calibration when the displayed value during a bump test fails to fall between 100% and 120% of the expected value for the gas.**

Sperian multi-calibration gas mixtures contain approximately 18% oxygen. During the bump test the oxygen sensor should read within +/- 0.5% of the level given on the calibration cylinder.

4.2 Fresh Air/Zero Calibration

Note: The NDIR-CO₂ sensor in the PHD6 may not be zero calibrated in fresh air. See section 4.4 for further instructions.

⚠WARNING Fresh air/zero calibrations may only be performed in an atmosphere that is known to contain 20.9% oxygen, 0.0% LEL and 0 PPM toxic gas.

To initiate the fresh air/zero calibration:

1. Press the MODE button three times within two seconds to begin the fresh air/zero calibration sequence. The PHD6 will briefly display AUTO CAL and then begin a 5-second countdown.
2. Press the MODE button before the end of the 5-second countdown to begin the fresh air/zero calibration. The fresh air/zero calibration is initiated when the PHD6 shows "Calibrating" on the screen.

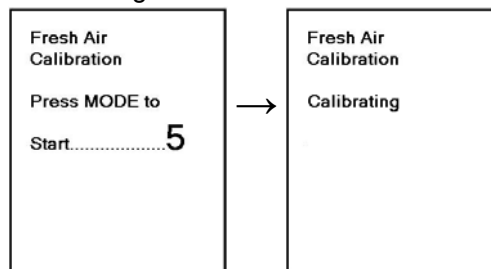

3. The PHD6 will indicate when the fresh air/zero calibration is complete. It will then proceed to a second 5-second countdown for the gas calibration. If gas calibration is not required, allow the countdown to reach 0 without pressing the MODE button.

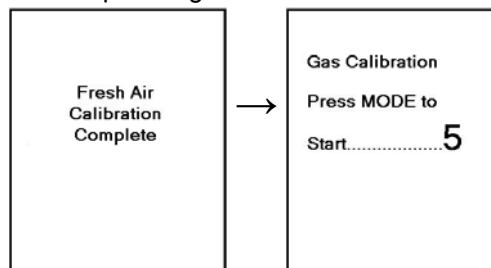

For instructions on the Gas Calibration, proceed to section 4.3.

4.2.1 Fresh air calibration failure

In the event of a fresh air calibration failure, the alarms will be activated and the instrument will display the following screen. Note that the sensor(s) that fail the zero calibration are shown (in this case, CO)

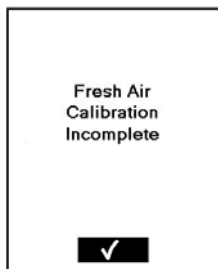

After 3 seconds, the PHD6 will return to the current gas readings screen and the visual and audible alarms will cease.

When calibration is due, the triangular warning symbol along with the span bottle icon the PHD6's status bar will show

If a successful fresh air calibration is not performed prior to instrument shut down, the PHD6 will note that Fresh Air Calibration is due during instrument start up.

Possible causes and solutions

1. The atmosphere in which the instrument is located is contaminated (or was contaminated at the time the instrument was last fresh air calibrated).
2. A new sensor has just been installed.
3. Instrument has been dropped or banged since last turned on.
4. There has been a significant change in temperature since the instrument was last used.

Recommended action:

Take the instrument to fresh air and allow readings to stabilize. Perform the fresh air/zero adjustment again. If the manual fresh air/zero procedure fails to correct the problem, perform the manual fresh air / zero calibration procedure as described in section 4.2.2 below.

4.2.2 Forced fresh air calibration

The PHD6 includes safeguards to prevent fresh air calibration in contaminated environments. If the standard fresh air calibration fails a second time, the instrument may be "forced" to accept the fresh air calibration by performing the manual fresh air calibration.

⚠WARNING Fresh air calibrations may only be performed in an atmosphere that is known to contain 20.9% oxygen, 0.0% LEL and 0 PPM toxic gas. Performing a fresh air calibration in a contaminated atmosphere may lead to inaccurate and potentially dangerous readings.

1. Initiate the standard fresh air / zero calibration sequence by pressing the MODE button three times in rapid succession. The 5-second countdown will begin.
2. Press and hold the down arrow key and then press the MODE button before the end of the

5-second countdown. Continue to hold the down arrow.

3. The fresh air/zero calibration is complete when the instrument begins another 5-second countdown for the gas calibration. If gas calibration is not required, allow the countdown to reach 0 without pressing the MODE button.

If the PHD6 still fails to calibrate after this procedure is attempted, contact Sperian.

4.2.3 Fresh air calibration in a contaminated atmosphere

To fresh air calibrate the PHD6 in a contaminated atmosphere, connect a cylinder of "zero air" containing 20.9% oxygen and no contaminants to the PHD6 and flow gas to the instrument. Then perform the fresh air calibration. See figure 4.1 above for setup.

4.3 Gas Calibration

Once the fresh air / zero calibration has been successfully completed, the PHD6 will automatically proceed to the automatic gas calibration countdown screen.

Press the MODE button before the countdown is complete to initiate the gas calibration. The screen will immediately show "APPLY GAS" and then list the sensors for calibration and the expected levels of calibration gas.

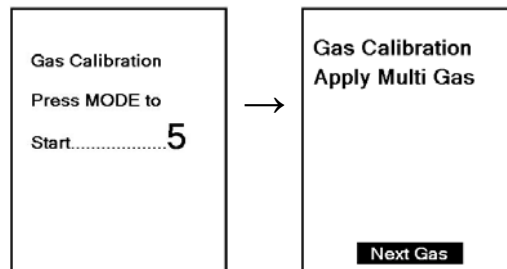

Note: Sperian recommends the use of multi-component calibration gas for calibrating the PHD6.

Reading	Cal	to
O2	19.1	
LEL	15	50
CO	11	50
H2S	16	25

Apply calibration gas. The readout will change to a numerical display almost immediately and show the current readings along with the expected calibration gas value.

If multiple cylinders are required to complete the calibration, the PHD6 will prompt the user to apply the next cylinder as needed.

As sensors are calibrated, the PHD6 will briefly show the reserve values for each sensor. The reserve values give an indication of the remaining sensitivity of the sensors. When the reserve value for a specific sensor reaches 0%, it is time to

LEL Cal to 50
Reserve 486%
CO Cal to 50
Reserve 402%
H2S Cal to 25
Reserve 256%

replace the sensor.

The oxygen sensor is tested for response to diminished oxygen levels during gas calibration. Sperian multi-gas calibration cylinders contain approximately 18.0% oxygen. In order to pass the gas calibration, the PHD6 must register an oxygen reading below

19.5% during gas calibration. If the detector fails to register the reduced oxygen levels during the gas calibration, it will show "Check O2 Sensor Response". Press MODE to acknowledge.

See section 4.3.2 below if the oxygen sensor does not detect the drop in oxygen level and fails the gas calibration.

Note: Disconnect the calibration assembly as soon as the calibration is complete.

4.3.1 Gas calibration failure: All sensors except oxygen

When there is a gas calibration failure, the display will show CAL Error and display the sensor whose calibration has failed.

If the instrument fails to recognize the correct type or concentration of calibration gas, it will show "no GAS".

When gas calibration is due, the PHD6's display will show the warning symbol while intermittently displaying the calibration bottle in the gas readings screen.

The PHD6 will also display a "Needs Cal" message for any sensors that are currently due for calibration during instrument start-up.

Possible causes of gas calibration failure and remedies:

1. Empty calibration gas cylinder. Verify that there is calibration gas in the cylinder.
2. Expired calibration gas cylinder. Verify that the expiration date on the cylinder has not passed.
3. Calibration gas setting does not correspond to calibration gas concentration. If the values on the calibration cylinder differ from the calibration gas settings in the PHD6, the PHD6's calibration gas settings must be changed to match the new values. Changing the calibration gas settings can be done manually through the MODE button or through BioTrak using a IrDA link to the instrument.
4. LEL only: Type of calibration gas (standard) has changed significantly. LEL calibration gas may be based on several different response standards. Methane, propane and pentane are the most common. If using a new cylinder of calibration gas, make sure that the type and amount of combustible gas is identical to that of the previous bottle.

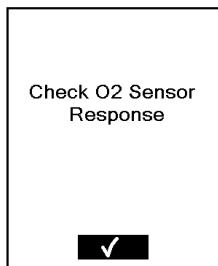

Sperian offers calibration gases in Methane, Propane Equivalent and Pentane Equivalent.

5. Dead sensor. Replace sensor.
6. Instrument problem. Return the instrument to Sperian. Call the phone number on the front of this manual.

4.3.2 Gas calibration failure: Oxygen sensors

Sperian multi calibration gas cylinders contains approximately 18.0% oxygen. The reduced oxygen level in the calibration gas cylinder allows the oxygen sensor's response to be tested in the same manner as the toxic and LEL sensors.

If the O2 sensor fails to register a reading below 19.5% during the gas calibration, the display will show "Check O2 Sensor Response". Press MODE to continue.

If the oxygen sensor fails to register the drop in oxygen during the gas calibration while being challenged with calibration gas containing less than 19.0% oxygen, it should be considered out of tolerance and retired from service immediately.

See section 5.2.4 under Gas Values for more information on the O2 sensor check.

⚠WARNING A sensor that cannot be calibrated or is found to be out of tolerance should be replaced immediately. An instrument that fails calibration may not be used until testing with known concentration test gas determines that accuracy has been restored, and the instrument is once again fit for use.

Possible causes and remedies for oxygen sensor failure:

1. Calibration gas cylinder does not contain a reduced level of oxygen. Verify that the cylinder contains less than 19.0% oxygen. To challenge the oxygen sensor without calibration gas, hold you breath of about 10 seconds and then **slowly** exhale directly onto the face of the sensor (in the same way you would attempt to fog up a piece of glass). If the descending oxygen alarm is set to 19.5%, the instrument should go into alarm after a few seconds. If the oxygen sensor fails to go into alarm during the exhalation test, the oxygen sensor must be replaced.
2. Oxygen sensor has just been replaced and has not had time to stabilize.
3. Oxygen sensor failure.

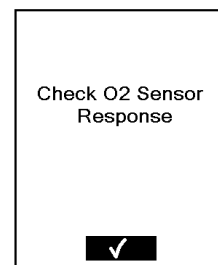

4.4 Special Calibration Instruction for NDIR CO₂ sensor

The Infrared CO₂ sensor requires two different gas sources for full calibration. The reason for this is that it is effectively impossible to zero calibrate a CO₂ sensor in ambient air because there is an unknown and varying amount of background CO₂ present in the atmosphere.

4.4.1 CO₂ Sensor True Zero

To determine if the CO₂ sensor requires zero calibration, connect the PHD6 to a cylinder of calibration gas that contains 0 PPM CO₂ while the instrument is in normal operation.

If the reading shows 0 PPM CO₂, then the CO₂ sensor does not require zero calibration. Disconnect the cylinder from the PHD6.

If the reading shows anything other than 0 PPM CO₂, leave the calibration gas on and press the MODE button three times within two seconds to initiate the zero calibration sequence. Press MODE again when prompted to begin the zero calibration. Instruments equipped with a CO₂ sensor will automatically show the message "Press MODE if applying Zero Air" with another 5-second countdown. Press MODE again to begin the true zero calibration and follow the instructions given on the screen. Once the zero calibration is complete, remove the zero air cylinder from the instrument and proceed to the gas calibration (if necessary).

The gas calibration of the CO₂ sensor is performed during the standard gas calibration that is described above in section 4.3. The PHD6 will automatically prompt the user to apply the CO₂ calibration gas during the standard gas calibration sequence.

4.5 Special Calibration Instructions for NDIR-CH₄ Sensor

In many ways, the NDIR-CH₄ sensor used in the PHD6 is similar to a hot bead LEL sensor. For the purpose of calibration, they are very different. While LEL sensors can be calibrated with a number of other gases when properly configured, The NDIR-CH₄ sensor must be calibrated with methane to the exact amount shown on the calibration gas cylinder. (This is different from LEL sensors, where methane may be used for calibration, but is often done at a scale that makes the readings mimic those given by a specific amount of propane or pentane).

⚠WARNING The NDIR CH₄ sensor in the PHD6 must be calibrated using methane (CH₄) calibration gas at the actual amount shown on the cylinder. The default calibration gas value for the NDIR-CH₄ sensor is 50% LEL. The appropriate calibration gas level for the 50% LEL default calibration gas setting is 2.50%/vol. CH₄. Use of inappropriate calibration gas may lead to

inaccurate and potentially dangerous readings.

5. Menu Options

The PHD6 operating firmware includes two menu options: the Basic Menu and the Main Menu.

5.1 Basic Menu

The Basic Menu is a shortened version of the Main Menu that offers immediate access to a few key functions including:

- PID On/Off (enable or disable the PID sensor)
- Displayed VOC (select the target compound for the VOC sensor)
- Contrast (display's light vs. dark setting)
- Main Menu access

5.1.1 Entering the Basic Menu

To access the Basic Menu, with the PHD6 on and the current gas readings screen shown, hold the MODE button down until the PHD6 beeps four times and the "Release MODE to Shut Down" is shown. Then continue to hold the MODE Button until the Basic Menu is shown.

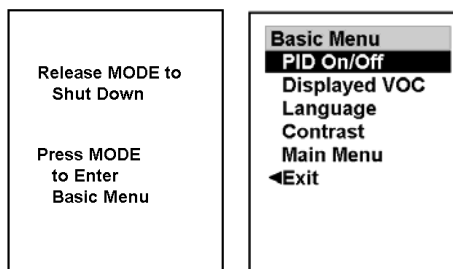

To navigate through the menu options, use the up and down navigation arrows to highlight the desired submenu and press MODE to enter the submenu.

5.2 Main Menu

The PHD6 is fully configurable through the Main Menu. The Main Menu contains 6 sub menus that lead to controls for the individual instrument functions.

To navigate through the menu options, use the up and down navigation arrows to highlight the desired submenu and press MODE to enter the submenu.

To navigate through the menu options, use the up and down navigation arrows to highlight the desired submenu and press MODE to enter the submenu.

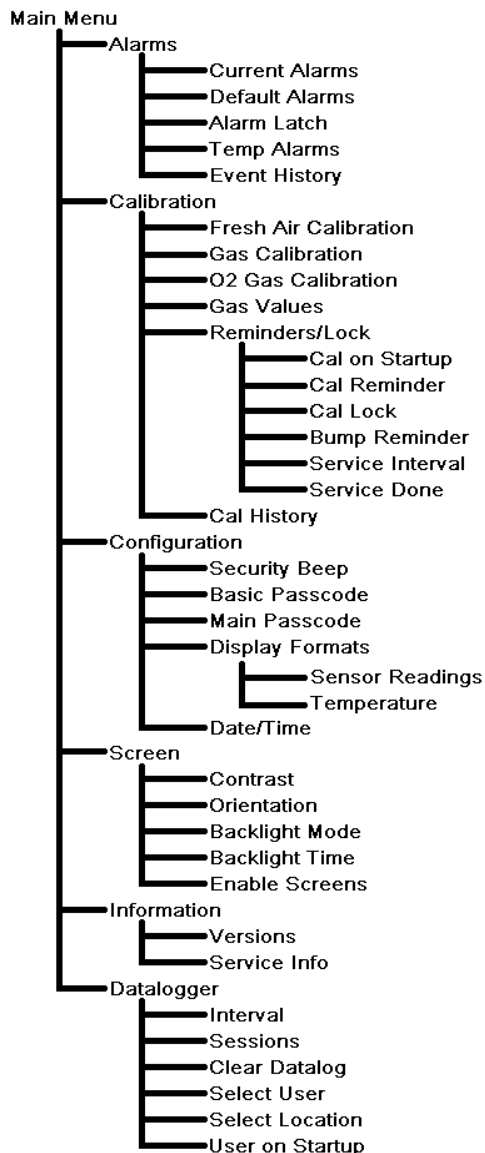

Main Menu Options Diagram

5.2.1 Entering the Main Menu

There are two paths into the main menu.

If the instrument is **on**, press and hold the MODE button down for three seconds until “Shutting Down” is shown, then release the MODE button. The next screen will show “shutting down...” along with two black blocks at the bottom of the screen. Press and hold the two arrow keys while the two blocks are shown to enter the main menu.

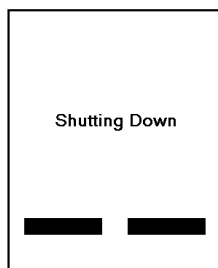

If the instrument is **off**, press the MODE button to start the instrument. When “Starting Session, Resetting Averages” is shown along with two black blocks, press and hold the two arrow keys while the two blocks are shown to enter the main menu.

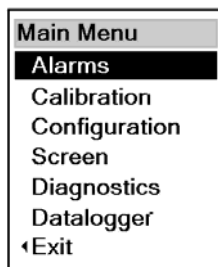

The Main Menu is the access point to 6 submenus that control virtually every aspect of the PHD6’s functionality.

NOTE: Changes made in the Main Menu can have a direct affect on the PHD6’s functionality and should only be made by those who are trained in proper gas detection and monitoring techniques.

5.2.2 Using the submenus.

In the Main Menu and the sub-menus, use the up and down arrows to navigate between the options and press MODE to enter. Three buttons will appear on the display to show the functions of the MODE button and the two navigation keys on any screen that allows instrument setup changes.

5.2.3 Alarms Menu

The Alarms Menu contains the following 6 submenus (options in parenthesis). Description follows (as needed).

- **Current Alarms** (select any sensor to view current sensor alarm settings, then select any current sensor alarm to make changes)
- **Default Alarms** (scroll to view default sensor alarms for each recognized sensor plus option to Set Default Alarms for all sensors)
- **Alarm Latch** (set on or off)

The PHD6’s alarms are self-resetting unless the alarm latch is enabled. With the PHD6’s alarm latch enabled, the audible and visible alarms will continue to sound after the atmospheric hazard has cleared. Press the MODE button to reset the alarms. If the alarm latch is disabled and the alarm condition is no longer present, the instrument will automatically return to normal operation, and the visible and audible alarms cease without further input from the user.

- **Temp Alarms** (enable or disable high and low temperature alarms)

If the operating temperature falls outside of the operating range of the PHD6, the instrument will go into alarm and the thermometer icon will be shown on the display.
- **Event History** (use up and down arrows to scroll through saved alarm events – includes time, duration and peak and average sensor readings during the event)
- **Vibrator** (if equipped) (enable or disable the vibrating alarm)

5.2.4 Calibration Menu

- **Fresh Air Cal** (initiates Fresh Air Calibration sequence)

⚠WARNING Fresh air/zero calibrations may only be performed in an atmosphere that

is known to contain 20.9% oxygen, 0.0% LEL and 0 PPM toxic gas.

- **Gas Calibration** (initiates Gas Calibration sequence (calibration gas required))
- **O₂ Gas Cal** (initiates true O₂ Zero Calibration sequence)

Note that this procedure requires a cylinder of calibration gas that contains 0.0% oxygen.

- **Gas Values** (select any sensor to view or change current calibration gas values).

Note: The selection of the calibration gas for the PID sensor is NOT linked to the displayed substance. A ratio is used to calculate readings for various VOCs against the calibration standard. See section 2.7 for more details on the PID gas values.

Note: In the case of the oxygen sensor, the O₂ gas setting can be used to enable or disable the oxygen sensor check that takes place during gas calibration with multi calibration gas. To disable the oxygen sensor check, select “No”.

⚠WARNING Disabling the oxygen sensor check may result in the failure to recognize an oxygen-deficient atmosphere.

Always use a multi cal gas cylinder containing 18% oxygen to calibrate the PHD6.

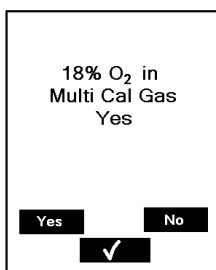

- **Reminders/Lock** (access to submenus below)

Cal on Startup (enable or disable)

When enabled, calibration is automatically initiated whenever the instrument is turned on. The calibration can be bypassed (unless Cal Due Lock is enabled) by letting the clock run out and proceeding to the current gas readings screen. Cal on Startup is usually disabled on new instruments and must be enabled by the user.

Cal Reminder: (adjust between every day and every 180 days). The default setting for standard instruments leaving the factory is 30 days.

To disable the cal reminder, set the value to 0.

Cal Lock: (enable or disable)

Enable to require calibration when the Cal Reminder is on. PHD6 automatically shuts down if Cal Lock is enabled, and calibration is due but not performed. Cal Lock is usually disabled on new instruments and must be enabled by the user.

Bump Reminder: (enable, disable and adjust between every day and every 30 days)

Used exclusively with the PHD6 IQ Express Dock. Reminds the user to process the instrument in the dock. To disable set the value to 0. The Bump Reminder is usually disabled on new instruments and must be enabled by the user.

Service Interval (enable, disable and adjust between every day and every 730 days (2 years))

The service interval is a reminder that tells the user when the instrument is due for service. The Service Interval is usually disabled on new instruments and must be enabled by the user.

Service Done (reset service date)

Used to reset the service interval following instrument service.

- **Cal History** (scroll through recent calibrations, includes span reserve listing – which allows for predictive maintenance)

5.2.5 Configuration Menu

- **Security Beep** (enable or disable)

Once enabled the PHD6 will emit a short audible beep and give a short flash on the LEDs at a user-defined interval to notify the user that the instrument is powered up and running. The Security Beep is usually disabled on new instruments and must be enabled by the owner.

- **Basic Passcode** (enable, disable and change passcode)

Enable to require the entry of a passcode to access the Basic Menu. The Basic Passcode is usually disabled on new instruments and must be enabled by the owner. To permit access to the Basic Menu, and restrict it from the Main Menu, the Basic Passcode must differ from the Main Passcode.

- **Main Passcode** (enable, disable and change passcode)

Enable to require the entry of a passcode to enter the Main Menu. The Main Passcode is usually disabled on new instruments and must be enabled by the owner. The Main Passcode can be used to enter both the Main Menu and the Basic Menu.

- **Display Formats** (contains submenus for sensor readings, sensor clamping and temperature)

- **Sensor readings** (for toxic gases select PPM (XX) or tenths-of-a-PPM (X.X) for sensors with this capability (such as H₂S). for NDIR-CH₄ choose between LEL and

CH₄ (the CH₄ reading will display in PPM from 1 – 10,000 PPM and then automatically switch over to %/Vol.))
Sensors that cannot be adjusted will show “Fixed”.

- **Temperature** (select display in Celsius or Fahrenheit) Most PHDs leave the factory configured to read temperature in Fahrenheit unless the customer requests otherwise.
- **Language** (select English, French or Spanish). Most PHDs leave the factory configured in English unless the customer requests otherwise.
- **Date/Time** (set time and date)

5.2.6 Screen Menu

- **Contrast** (screen contrast setting)
- **Orientation** (shifts display to be viewable from top or bottom of the instrument)
- **Backlight Mode** (select continuous, Timed Off or Time Auto)
Select **Continuous** to have the backlight on at all times,
Select **Timed Off** to require a MODE press or an alarm condition to activate the backlight. The default setting for most new PHD6 instruments when leaving the factory is to turn the backlight off after 20 seconds.
Select **Time Auto** to enable the automatic backlight for low light conditions.
- **Backlight Time** (set the time before the backlight turns off in Time Off Mode)
- **Enable Screens** (select the screens that are accessible by sequentially pressing the MODE button including: Peak, Average, STEL and TWA screens).

5.2.7 Information Menu

- **Versions** (view instrument serial number, software version, and time and date of instrument manufacture)
- **Service Info** (view Sperian Instrumentation's phone contact numbers).

5.2.8 Datalogger Menu

- **Interval** (set datalogger interval between 1 second and 1 hour) (menu option only not available in Black Box Datalogger versions)
The datalogger samples continuously, so the data stream must be broken into intervals to be recorded. The datalogging interval defines the frequency of the breaks in the data stream. The interval may be set anywhere between one second and one hour by using the navigation arrows as detailed below. The default datalogging interval is 1 minute. At a one-minute interval, the PHD6 will log a minimum of 63 hours of data before the oldest data is overwritten by newer data.

- **Sessions** (view datalogger session data including date, time, interval, temperature and sensor minimum and maximum readings)
- **Clear Datalog** (clears all information from the datalogger)
- **Select User** (User name will be saved in the session data)
Users' names must be entered in BioTrak to appear in the user list.
- **Select Location** (Location name will be saved in the session data)
Location names must be entered in BioTrak to appear in the location list.
- **User on Startup** (enable or disable a prompt to select user and location at startup)
User and location names must be entered into the instrument via BioTrak before this option can be enabled.

6. Maintenance

⚠WARNING To prevent ignition of flammable or combustible atmospheres, disconnect power before servicing any parts in the PHD6.

6.1 Batteries

The PHD6 is powered by interchangeable alkaline and Li-Ion rechargeable battery packs.

To remove the battery pack first loosen the top center screw on the back of the instrument, then gently pull the top of the battery away from the instrument. The battery is hinged from below. Remove the battery once the top clears the upper housing by pulling up and away.

CAUTION Always turn the PHD6 off prior to removing the battery pack. Removal of the battery pack with the instrument turned on may cause corruption of stored data in the PHD6.

Note: Center screw on ATEX / European version may be slightly different.

6.2 Replacing alkaline batteries

The alkaline battery pack contains three AA alkaline batteries.

⚠WARNING The PHD6 must be located in a non-hazardous location whenever alkaline batteries are removed from the alkaline battery pack. Removal of the alkaline batteries from the battery pack in a hazardous area may impair intrinsic safety.

⚠WARNING Use only Duracell MN1500 or Ultra MX1500, Eveready Energizer E91-LR6, Eveready EN91 batteries. Substitution of batteries may impair intrinsic safety.



To replace the alkaline batteries:

1. Remove the battery pack from the PHD6 as discussed in above in section 6.1.
2. Loosen the two screws at the top of the battery pack by turning each ¼ turn counterclockwise.
3. Remove the three alkaline batteries and replace them. Be sure to align the positive and negative ends in accordance with the diagram under each battery.
4. Reinstall the back cover plate that was removed in step 2.
5. Return the battery pack to the PHD6 and re-tighten the top center screw. The PHD6 will automatically turn itself on once the battery pack is reinstalled.

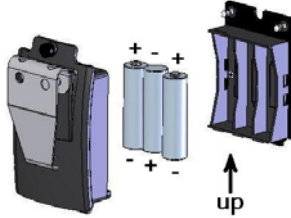

6.3 Maintaining Li-Ion battery packs

The PHD6 may be equipped with a rechargeable Li-Ion (Lithium Ion) battery pack.

6.3.1 Storage guidelines for the Li-Ion battery

Never store Li-Ion -version PHD6 instruments at temperatures above 30 degrees Celsius (86 degrees Fahrenheit). Li-Ion batteries may suffer deterioration resulting in damage to the internal components when stored at high temperatures. The battery may be irretrievably damaged resulting in reduced battery capacity and voltage. Sperian recommends leaving PHD6 instruments with Li-Ion rechargeable batteries on the charger when not in use.

6.3.2 Charging guidelines for Li-Ion battery

The Li-Ion battery in the PHD6 should never be charged at temperatures lower than 5 degrees Celsius (40 degrees Fahrenheit) or higher than 30 degrees Celsius (86 degrees Fahrenheit). Charging at temperature extremes can permanently damage the PHD6 Li-Ion battery.

⚠WARNING The PHD6 must be located in a non-hazardous location during the charging cycle. Charging the PHD6 in a hazardous location may impair intrinsic safety.

6.3.3 Charging procedure for Li-Ion battery

⚠WARNING Do not charge the PHD6 with any charger other than the appropriate Sperian PHD6 charger. Standard versions of the PHD6 must be charged with the UL/CSA-approved charger, which is Sperian part number 54-54-001. European versions of the PHD6 must be charged with the ATEX-approved Sperian PHD6 charger.

1. Verify that the instrument is turned off. (If it is not, press the MODE button for three

seconds until the message "Release Button" appears.)

2. Plug the power supply in. The red LED is labeled "Power" and will be lit whenever the charger is plugged into a power source.
3. Insert the PHD6 into the charging cradle bottom side down with the display facing forward. The green LED on the charger is labeled "Charge" and will blink while the battery is charging.
4. When the battery is fully charged, the green "Charge" LED will be lit and not blinking.

See section 5.3.4 for battery troubleshooting guidelines.

6.3.4 Charging with the pump attached

The PHD6 with pump attached may be charged according to the instruction given in section 6.3.3 above.

6.3.5 Battery troubleshooting

If the green "Charge" LED on the charger fails to light when the PHD6 with Li-Ion battery pack is placed in the charger, remove the instrument from the charger and press the MODE button to attempt to start the instrument.

If the battery has been inserted into the charger without the instrument, return it to the instrument prior to attempting the restart.

1. If the PHD6 starts and the battery icon is full, then the battery is fully charged and may be used as is. In this case, the charger has recognized that the battery is charged and will not charge it any further.
2. If the PHD6 fails to turn on, then the battery may be severely discharged and should be returned to the charger. The charger will then begin a very slow recharge in order to protect the battery. The green "Charge" LED may not be lit during the first four hours of the slow recharge. If the "Charge" LED has still not been lit after four hours, the battery pack or charger is probably damaged.
3. If the PHD6 starts and any battery level other than full is indicated, then either the battery is damaged or the charger is damaged. Call Sperian for further instructions.

6.4 Sensors

6.4.1 Sensor replacement

The sensors in the PHD6 are located in a vented compartment at the bottom of the instrument.

To install a sensor:

1. Turn the PHD6 off.
2. Remove the battery pack as described in section 6.1. This will automatically disconnect power from the instrument.
3. Remove the four screws that are located below the battery pack insertion from the back face of the PHD6.

4. Turn the instrument over to reveal the front face and gently remove the sensor cover.
5. Remove the sensor that is to be replaced.
6. Insert the new sensor into the appropriate location on the sensor board.
7. Reinstall the sensor cover by aligning it properly over the sensors and securing it with the four screws that were removed in step 3.
8. Reattach the battery pack and re-tighten the top center screw.
9. New sensors must be allowed to stabilize prior to use according to the following schedule. The detector must be powered off and a functional battery pack must be installed for the sensor to stabilize.

Sensor	Stabilization Period
Oxygen (O ₂)	1 hour
LEL	none
PID	5 minutes
NDIR-CH ₄ or NDIR-CO ₂	1 minute
All Toxic Sensors except NO	15 minutes
NO (nitric oxide)	24 hours

Note: Steps 9 and 10 assume that the sensor stabilization period has passed.

10. Perform the Fresh Air/Zero calibration and the Gas calibration as discussed in sections 4.2 and 4.3.

6.4.2 Care and maintenance of PID sensors

The two critical components of a PID sensor are the electrode stack and the lamp. The electrode stack can be replaced in the field. The lamp can be cleaned or replaced in the field. The frequency of maintenance to both items will vary with the type of usage and the nature of the contaminants to which the sensor is exposed.



As a general rule, baseline shifts tend to be caused by the electrode stack and losses of sensitivity tend to be caused by the lamp.

6.4.2.1 Troubleshooting the PID

When to replace the electrode stack:

1. Baseline reading climbs following fresh air zeroing of the sensor.
2. PID sensor becomes sensitive to humidity.
3. Baseline becomes generally unstable.
4. Baseline shifts when the instrument is in motion.

When to clean the PID lamp

Loss of sensitivity in the sensors as shown during bump-testing (reading will be low).

When to replace the PID lamp

If the cleaning of the lamp fails to correct a loss of sensitivity, the lamp should be replaced.

6.4.2.2 Cleaning and replacing PID components

To remove the lamp and stack

1. Wash your hands thoroughly.
2. On a clean surface, remove the PID sensor from the PHD6 as described above (section 6.4.1 steps 1-5).
3. Place one finger on top of the sensor and insert the stack removal tool into the two slots at the top side of the sensor body. Squeeze gently until the spring releases and the stack can be removed from the top of the sensor. The lamp is spring-loaded against the stack, so keeping a finger on top of the stack prevents their ejection from the sensor body.
4. Gently remove the stack and pull the lamp and spring out of the sensor body. Do not touch the top of the lamp window with bare fingers.
5. Set the spring aside.

To replace the stack or lamp

1. Discard the used lamp, stack or both as needed and rebuild with replacement part(s).
2. Drop the spring into the center of the sensor body and place the lamp on top of it. Do not touch the top of the lamp window with bare fingers.
3. Snap the stack into place against the lamp so that the sensor is whole again and the stack cannot be removed without the removal tool.
4. The sensor should have a gasket and a filter on it. If necessary install a sensor filter and gasket on top of the sensor.
5. Reinstall the sensor into the PHD6.
7. Reassemble the PHD6.
8. Calibrate the PID prior to use after the 5-warm up periods ends.

To clean the lamp

1. Follow the directions above to remove the lamp from the instrument.
2. Make sure your hands are clean.
3. Coat the cotton swab in a thin layer of lamp cleaning powder of 0.1 to 0.25 μm α -alumina.
4. Pick up the lamp with the other hand. Do not touch the top of the lamp window with bare fingers.
5. Using the cotton swab dipped in the cleaning powder, polish the top of the lamp with a swirling motion. Cleaning typically takes about 30 seconds and is finished when the swab starts to squeak.
6. Reassemble the sensor and the PHD6. See steps 3-8 above in the directions to replace the stack or lamp.

6.5 Sample probe assembly

The PHD6's sample draw probe is the standard probe assembly from Sperian. The illustration below gives a breakdown of all parts in the

sample draw probe with part numbers. The sample probe handle contains moisture barrier and particulate filters designed to remove contaminants that might otherwise harm the instrument.

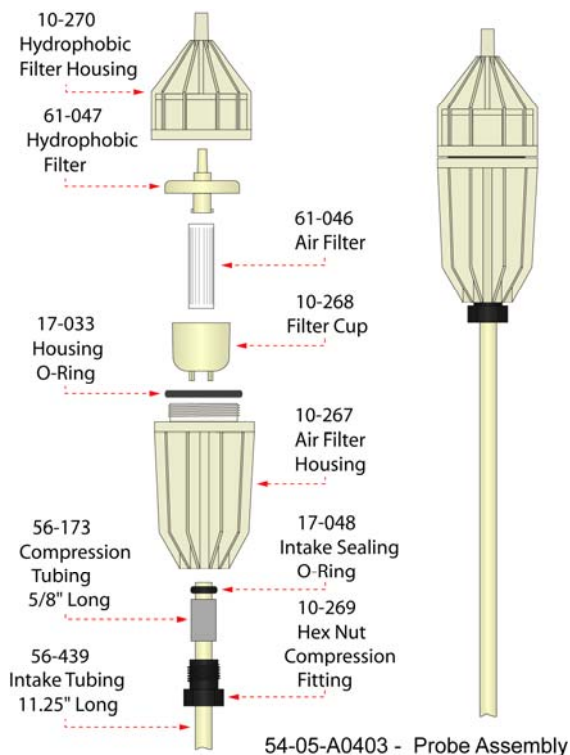

Sample probe filters should be replaced whenever visibly discolored due to contamination.

CAUTION: Never perform remote sampling without the sample probe and hose assembly. The sample probe handle contains replaceable filters designed to block moisture and remove particulate contaminants. If the pump is operated without the probe assembly in place, contaminants may cause damage to the pump, sensors and internal components of the PHD6.

Particulate contaminants are removed by means of a cellulose filter. The hydrophobic filter includes a Teflon™ barrier which blocks the flow of moisture as well as any remaining particulate contaminants.

6.5.1 Changing sample probe filters

The threaded sample probe handle accesses the filters. The particulate filter is held in place by means of a clear filter cup. To replace the particulate filter, remove the old filter and cup, insert a new filter into the cup, and slide the cup back into place in the probe handle. The hydrophobic barrier filter fits into a socket in the rear section of the probe handle. (The narrow end of the hydrophobic barrier filter is inserted towards the rear of the handle.)

To avoid accidentally introducing particulate contaminants into the system, turn the sample

probe upside-down prior to removing either the hydrophobic filter or the particulate filter.

The following replacement filter kits are currently available from Sperian:

Part No.	Kit	#Particulate	#Hydrophobic
54-05-K0401	Standard	10	3
54-05-K0402	Economy	10	0
54-05-K0403	Economy	30	10
54-05-K0404	Bulk	0	25
54-05-K0405	Bulk	100	0

6.5.2 Changing sample probe tubes (wands)

The standard 11.5" long butyrate probe tube is held in place with a hex-nut compression fitting and compression sleeve. The standard probe tube can be interchanged with other custom length sections of 1/4" OD tubing, or probe tubes made of other materials (such as stainless steel).

Probe tubes are exchanged by loosening the hex-nut compression fitting, removing the old tube, sliding the compression sleeve into place around the new tube, inserting the new tube into the probe handle, then replacing and tightening the hex-nut.

Note: The sample probe must be checked for leakage (as discussed in Section 3.1.1) whenever filters or probe tubes are exchanged or replaced before being returned to service.

6.6 PHD6 Pump Maintenance

PHD6 pumps are fairly maintenance free with the exception of the replacement of the pump filters on a regular basis.

6.6.1 Replacing pump filters

1. Remove the two screws that hold the inlet port to the pump.
2. Gently pull the dust filter holder free of the pump.
3. Remove and replace the dust filter that is located in the holder.
4. The hydrophobic filter is located beneath the inlet port in the pump housing. Use a small screwdriver or other object to punch through the filter and remove it. The gasket that sits between the inlet port and the filter should come out with the filter.
5. Place the new hydrophobic filter with the filter side down in place of the one removed in step 4. The gasket should be located on top of the filter and should sit against the dust filter holder, which will be reinstalled in step 6.
6. Replace the dust filter holder (which now has a new filter in it) and secure it with the two screws removed in step 1.

Appendices

Appendix A Toxic gas measurement – Warning, Danger, STEL and TWA alarms

Many toxic substances are commonly encountered in industry. The presence of toxic substances may be due to materials being stored or used, the work being performed, or may be generated by natural processes. Exposure to toxic substances can produce disease, bodily injury, or death in unprotected workers.

It is important to determine the amounts of any toxic materials potentially present in the workplace. The amounts of toxic materials potentially present will affect the procedures and personal protective equipment that must be used. The safest course of action is to eliminate or permanently control hazards through engineering, workplace controls, ventilation, or other safety procedures. Unprotected workers may not be exposed to levels of toxic contaminants that exceed Permissible Exposure Limit (PEL) concentrations. Ongoing monitoring is necessary to insure that exposure levels have not changed in a way that requires the use of different or more rigorous procedures or equipment.

Airborne toxic substances are typically classified on the basis of their ability to produce physiological effects on exposed workers. Toxic substances tend to produce symptoms in two time frames.

Higher levels of exposure tend to produce immediate (acute) effects, while lower levels of long-term (chronic) exposure may not produce physiological symptoms for years.

Hydrogen sulfide (H_2S) is a good example of an acutely toxic substance which is immediately lethal at relatively low concentrations. Exposure to a 1,000 ppm (parts per million) concentration of H_2S in air produces rapid paralysis of the respiratory system, cardiac arrest, and death within minutes.

Carbon monoxide (CO) is a good example of a chronically toxic gas. Carbon monoxide bonds to the hemoglobin molecules in red blood cells. Red blood cells contaminated with CO are unable to transport oxygen. Although very high concentrations of carbon monoxide may be acutely toxic, and lead to immediate respiratory arrest or death, it is the long term physiological effects due to chronic exposure at lower levels that take the greatest toll of affected workers. This is the situation with regards to smokers, parking garage attendants, or others chronically exposed to carbon monoxide in the workplace. Exposure levels are too low to produce immediate symptoms, but small repeated doses reduce the oxygen carrying capacity of the blood over time to dangerously low levels. This partial impairment of the blood supply may lead over time to serious physiological consequences.

Because prudent monitoring programs must take both time frames into account, there are two independent exposure measurements and alarm types built into the PHD6 design.

1. Warning and Danger Alarms

OSHA has assigned some, but not all, toxic substances with a ceiling level which represents the highest concentration of a toxic substance to which an unprotected worker should ever be exposed, even for a very short time. The default Warning and Danger

alarm levels in the PHD6 are less than or equal to the OSHA-assigned ceiling levels for both CO and H_2S . **Never enter an environment even momentarily when concentrations of toxic substances exceed the level of either the Warning or the Danger Alarm.**

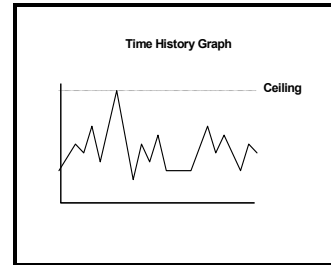

2. Time Weighted Average (TWA)

The maximum average concentration to which an unprotected worker may be exposed over an eight hour working day is called the Time Weighted Average or TWA value. TWA values are calculated by taking the sum of exposure to a particular toxic gas in the current operating session in terms of parts-per-million-hours and dividing by an eight-hour period.

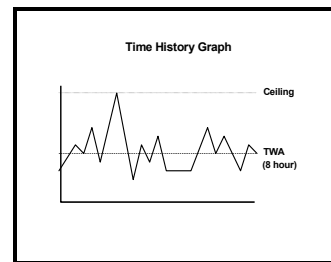

3. Short Term Exposure Limits (STEL)

Toxic substances may have short term exposure limits which are higher than the eight hour TWA. The STEL is the maximum average concentration to which an unprotected worker may be exposed in any fifteen minute interval during the day. During this time, neither the eight hour TWA or the ceiling concentration may be exceeded.

Any fifteen minute periods in which the average STEL concentration exceeds the permissible eight hour TWA must be separated from each other by at least one hour. A maximum of four of these periods are allowed per eight hour shift.

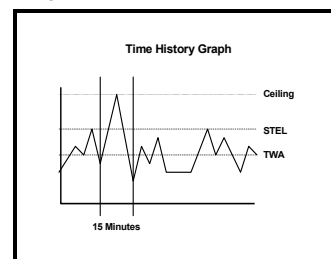

Appendix B Calibration Frequency Recommendation

One of the most common questions that we are asked at Sperian Instrumentation is: ***“How often should I calibrate my gas detector?”***

Sensor Reliability and Accuracy

Today’s sensors are designed to provide years of reliable service. In fact, many sensors are designed so that with normal use they will only lose 5% of their sensitivity per year or 10% over a two-year period. Given this, it should be possible to use a sensor for up to two full years without significant loss of sensitivity.

Verification of Accuracy

With so many reasons why a sensor can lose sensitivity and given the fact that dependable sensors can be key to survival in a hazardous environment, frequent verification of sensor performance is paramount.

There is only one sure way to verify that a sensor can respond to the gas for which it is designed. That is to expose it to a known concentration of target gas and compare the reading with the concentration of the gas. This is referred to as a “bump” test. This test is very simple and takes only a few seconds to accomplish. **The safest course of action is to do a “bump” test prior to each day’s use.** It is not necessary to make a calibration adjustment if the readings fall between 90%* and 120% of the expected value. As an example, if a CO sensor is checked using a gas concentration of 50 PPM it is not necessary to perform a calibration unless the readings are either below 45 PPM or above 60 PPM.

***The Canadian Standards Association (CSA) requires the instrument to undergo calibration when the displayed value during a bump test fails to fall between 100% and 120% of the expected value for the gas.**

Lengthening the Intervals between Verification of Accuracy

We are often asked whether there are any circumstances in which the period between accuracy checks may be lengthened.

Sperian Instrumentation is not the only manufacturer to be asked this

question! One of the professional organizations to which Sperian Instrumentation belongs is the Industrial Safety Equipment Association (ISEA). The “Instrument Products” group of this organization has been very active in developing a protocol to clarify the minimum conditions under which the interval between accuracy checks may be lengthened.

A number of leading gas detection equipment manufacturers have participated in the development of the ISEA guidelines concerning calibration frequency. Sperian Instrumentation’s procedures closely follow these guidelines.

If your operating procedures do not permit daily checking of the sensors, Sperian Instrumentation recommends the following procedure to establish a safe and prudent accuracy check schedule for your Sperian instruments:

1. During a period of initial use of at least 10 days in the intended atmosphere, check the sensor response daily to be sure there is nothing in the atmosphere that is poisoning the sensor(s). The period of initial use must be of sufficient duration to ensure that the sensors are exposed to all conditions that might have an adverse effect on the sensors.
2. If these tests demonstrate that it is not necessary to make adjustments, the time between checks may be lengthened. The interval between accuracy checking should not exceed 30 days.
3. When the interval has been extended the toxic and combustible gas sensors should be replaced immediately upon warranty expiration. This will minimize the risk of failure during the interval between sensor checks.
4. The history of the instrument response between verifications should be kept. Any conditions, incidents, experiences, or exposure to contaminants that might have an adverse effect on the calibration state of the sensors should trigger immediate re-verification of accuracy before further use.

5. Any changes in the environment in which the instrument is being used, or changes in the work that is being performed, should trigger a resumption of daily checking.
6. If there is any doubt at any time as to the accuracy of the sensors, verify the accuracy of the sensors by exposing them to known concentration test gas before further use.

Gas detectors used for the detection of oxygen deficiencies, flammable gases and vapors, or toxic contaminants must be maintained and operated properly to do the job they were designed to do. Always follow the guidelines provided by the manufacturer for any gas detection equipment you use!

If there is any doubt regarding your gas detector’s accuracy, do an accuracy check! All it takes is a few moments to verify whether or not your instruments are safe to use.

One Button Auto Calibration

While it is only necessary to do a “bump” test to ensure that the sensors are working properly, all current Sperian gas detectors offer a one-button auto calibration feature. This feature allows you to calibrate a Sperian gas detector in about the same time as it takes to complete a “bump” test. The use of automatic bump test and calibration stations can further simplify the tasks, while automatically maintaining records.

Don't take a chance with your life. Verify accuracy frequently!

Please read also Sperian Instrumentation’s application note: AN20010808 “Use of ‘equivalent’ calibration gas mixtures”. This application note provides procedures to ensure safe calibration of LEL sensors that are subject to silicone poisoning.

Sperian Instrumentation’s website is located at:

<http://www.biosystems.com>

Appendix C PHD6 Sensor Information

Part No.	Description	Range	Resolution
54-54-80	LEL Combustible Gas	0 – 100% LEL	1% LEL
54-54-90	O ₂ Oxygen	0 – 30% by Volume	0.1%
54-54-01	CO Carbon Monoxide	0 – 1000 PPM	1 PPM
54-54-19	CO-H CO Minus, reduced sensitivity to H ₂	0 – 1000 PPM	1 PPM
54-54-05	CO+ CO Plus dual purpose CO / H ₂ S (Provides a non-specific readout for CO and H ₂ S)	CO: 0 – 1000 PPM H ₂ S: 0 – 200 PPM	1 PPM
54-54-02	H ₂ S Hydrogen Sulfide	0 – 200 PPM	1 PPM
54-54-14	Duo-Tox Dual Channel CO/H ₂ S Provides substance specific readouts for CO & H ₂ S	CO: 0 – 1000 PPM H ₂ S: 0 – 200 PPM	1 PPM 1 PPM
54-54-03	SO ₂ Sulfur dioxide	0 – 25 PPM	0.1 PPM
54-54-21	NH ₃ Ammonia	0 – 100 PPM	1 PPM
54-54-18	Cl ₂ Chlorine (specific)	0 – 50 PPM	0.1 PPM
54-54-20	ClO ₂ Chlorine dioxide (specific)	0 – 5 PPM	0.01 PPM
54-54-06	NO Nitric oxide	0 – 350 PPM	1 PPM
54-54-09	NO ₂ Nitrogen dioxide	0 – 50 PPM	0.1 PPM
54-54-23	HCN Hydrogen cyanide	0 – 100 PPM	0.2 PPM
54-54-13	PH ₃ Phosphine	0 – 20 PPM	0.1 PPM
54-54-50	NDIR CO ₂ Carbon dioxide	50,000 PPM (5.0%/vol)	10PPM
54-54-51	NDIR CH ₄ Methane	0 – 990 PPM 1.00%/vol – 5.00%/vol	10 PPM .01%/vol
54-54-52	PID Volatile Organic Compound (VOCs)	200PPM	.1PPM

Appendix D Electrochemical Toxic Sensor Cross-Sensitivity

The table below provides the cross-sensitivity response of the PHD6 electrochemical toxic gas sensors to common interference gases. The values are expressed as a percentage of the primary sensitivity, or the reading of the sensor when exposed to 100ppm of the interfering gas at 20°C. These values are approximate. The actual values depend on the age and condition of the sensor. Sensors should always be calibrated to the primary gas type. Cross-sensitive gases should not be used as sensor calibration surrogates without the express written consent of Biosystems.

SENSOR	CO	H2S	SO2	NO	NO2	Cl2	ClO2	H2	HCN	HCl	NH3	C2H4	C2H2
Carbon Monoxide (CO)	100	10	5	10	-15	-5	-15	50	15	3	0	75	250
Carbon Monoxide (CO+)	100	350	50	30	-60	-60	-120	50	n/d	n/d	0	75	250
Carbon Monoxide (CO-H)	100	2	0.5	3	-0.5	-0.5	-1.5	5	n/d	n/d	0.1	35	(+)
Hydrogen Sulfide (H2S)	0.5	100	20	2	-20	-20	-60	0.2	0	0	0	n/d	n/d
Sulfur Dioxide (SO2)	1	0	100	<8	-100	-70	-150	0.2	n/d	n/d	<0.1	15	100
Nitrogen Dioxide (NO2)	<0.1	-40	-2.5	<0.5	100	100	270	<0.1	n/d	n/d	<0.1	n/d	0.1
Nitric Oxide (NO)	0.1	≤15	≤10	100	≤30	15	n/d	0.1	n/d	n/d	n/d	n/d	n/d
Chlorine (Cl2) (specific)	0	-3	<1	n/d	12	100	20	0	0	0	0	0	0
Chlorine (Cl2) (non-specific)	0	-20	<5	0	120	100	300	0	n/d	n/d	0	n/d	n/d
Chlorine Dioxide (ClO2) (specific)	0	-25	-5	n/d	n/d	60	100	0	0	0	n/d	0	0
Chlorine Dioxide (ClO2) (non-specific)	0	-7	<2	0	40	<35	100	0	n/d	n/d	0	n/d	n/d
Ammonia (NH3)	<1	<10	2	n/d	0	0	n/d	0	0	0	100	0	0
Phosphine (PH3)	0.5	25	20	n/d	(-)	(-)	(-)	0.1	n/d	n/d	n/d	1	0.5
Hydrogen Cyanide (HCN) (old style 54-54-10)	0.5	200	100	-5	-70	-50	-150	0	100	65	-5	0	n/d
Hydrogen Cyanide (HCN) (new style 54-54-23)	0	0**	n/d	n/d	-70	n/d	n/d	0	100	n/d	n/d	n/d	n/d

** Sensor manufacturer rates Cross Sensitivity for (54-54-23) HCN sensor to H2S as follows for 20 PPM exposure at 20°C: “Short gas exposure in minute range; after filter saturation: ca. 40 PPM reading”.

n/d = no data

Sperian Instrumentation Warranty Gas Detection Products

General

Sperian Protection Instrumentation, LLC (hereafter Sperian) warrants gas detectors, sensors and accessories manufactured and sold by Sperian, to be free from defects in materials and workmanship for the periods listed in the tables below.

Damages to any Sperian products that result from abuse, alteration, power fluctuations including surges and lightning strikes, incorrect voltage settings, incorrect batteries, or repair procedures not made in accordance with the Instrument's Reference Manual are not covered by the Sperian warranty.

The obligation of Sperian under this warranty is limited to the repair or replacement of components deemed by the Sperian Instrument Service Department to have been defective under the scope of this standard warranty. To receive consideration for warranty repair or replacement procedures, products must be returned with transportation and shipping charges prepaid to Sperian at its manufacturing location in Middletown, Connecticut, or to a Sperian Authorized Warranty Service Center. It is necessary to obtain a return authorization number from Sperian prior to shipment.

THIS WARRANTY IS EXPRESSLY IN LIEU OF ANY AND ALL OTHER WARRANTIES AND REPRESENTATIONS, EXPRESS OR IMPLIED, INCLUDING BUT NOT LIMITED TO, THE WARRANTY OF FITNESS FOR A PARTICULAR PURPOSE. SPERIAN WILL NOT BE LIABLE FOR LOSS OR DAMAGE OF ANY KIND CONNECTED TO THE USE OF ITS PRODUCTS OR FAILURE OF ITS PRODUCTS TO FUNCTION OR OPERATE PROPERLY.

Instrument & Accessory Warranty Periods

Product(s)	Warranty Period
Biosystems PHD6, PhD ⁵ , PhD Lite, PhD Plus, PhD Ultra, Cannonball3, MultiVision, Toxi, Toxi/Oxy Plus, Toxi/Oxy Ultra, ToxiVision, Ex Chek	As long as the instrument is in service
ToxiPro [®] , MultiPro	2 years from date of purchase
ToxiLtd [®]	2 years after activation or 2 years after the "Must Be Activated By" date, whichever comes first
Toxi3Ltd [®]	3 years after activation or 3 years after the "Must Be Activated By" date, whichever comes first
Mighty-Tox 2 Prorated credit is given towards repair or purchase of a new unit of the same type.	0 – 6 months of use 100% credit 6 – 12 months of use 75% credit 12 – 18 months of use 50% credit 18 – 24 months of use 25% credit
IQ Systems, Series 3000, Airpanel, Travelpanel, ZoneGuard, Gas✓Chek1 and Gas✓Chek4	One year from the date of purchase
Battery packs and chargers, sampling pumps and other components, which by their design are consumed or depleted during normal operation, or which may require periodic replacement	One year from the date of purchase

Sensor Warranty Periods

Instrument(s)	Sensor Type(s)	Warranty Period
Biosystems PHD6, PhD Plus, PhD Ultra, PhD ⁵ , PhD Lite, Cannonball3, MultiVision, MultiPro, ToxiVision, ToxiPro [®] , Ex Chek	O ₂ , LEL**, CO, CO+, H ₂ S & Duo-Tox	2 Years
	All Other Sensors	1 Year
Toxi, Toxi/Oxy Plus, Toxi/Oxy Ultra	CO, CO+, H ₂ S	2 Years
	All Other Sensors	1 Year
All Others	All Sensors	1 Year

** Damage to combustible gas sensors by acute or chronic exposure to known sensor poisons such as volatile lead (aviation gasoline additive), hydride gases such as phosphine, and volatile silicone gases emitted from silicone caulks/sealants, silicone rubber molded products, laboratory glassware greases, spray lubricants, heat transfer fluids, waxes & polishing compounds (neat or spray aerosols), mold release agents for plastics injection molding operations, waterproofing formulations, vinyl & leather preservatives, and hand lotions which may contain ingredients listed as cyclomethicone, dimethicone and polymethicone (at the discretion of Sperian's Instrument Service department) void Sperian Instrumentation's Standard Warranty as it applies to the replacement of combustible gas sensors.